



Climate and energetics



IMPACT OF ENERGETICS ON CLIMATE

Energetics is one of the most important sectors of the national economy, without which development of other sectors is not possible

Energy consumer uses three types of energy with varying impact on climate change:

- Energy resources
- Heat
- Electric power

Energetics includes various stages of the exploitation of energy resources:

- **Energy production and supply** to energy consumers
- **Energy conversion** of energy resources to an appropriate form applicable for consumer - heat or electricity
- **Supply** of heat and electricity to consumers



A hand holding a glowing lightbulb against a sunset background. The lightbulb is illuminated, casting a warm glow. The background shows a sunset over a body of water with silhouettes of buildings or structures in the distance.

Energy production is carried out using various **energy resources** which have different affect on climate change:

- **Non-renewable (fossil) energy resources**: oil, natural gas, peat and coal – by using them greenhouse gases (GHG) are emitted in the atmosphere significantly affecting climate change
- **Renewable energy resources**: hydropower, bioenergy, geothermal, solar and wind energy, wave and tidal energy – are considered to be climate-neutral resources
- **Nuclear power** – its use has no affects on global climate change

Climate technologies are sets of processes, methods and techniques, the use of which reduces the impact on climate change

The Climate Change Performance Index considering elements such as emissions levels, the recent trend in emissions, renewable energy, efficiency, and policy indicates actions of world countries regarding climate change

The table summarizes the performance ratings of peer countries in the G20 (green – good, yellow – moderate, orange – poor, red – very poor)

Rank	Country	Rank	Country
4	Denmark	32	Finland
5	Sweden	33	Latvia
6	United Kingdom	34	Croatia
7	Portugal	35	Greece
8	Cyprus	36	Austria
10	Ireland	37	South Africa
12	France	40	Poland
14	Hungary	41	Bulgaria
15	Slovak Republic	42	Netherlands
16	Belgium	44	United States
17	Italy	45	China
18	Mexico	46	Estonia
19	Slovenia	48	Argentina
20	Malta	49	Brazil
21	Lithuania	51	Turkey
22	Germany	53	Japan
23	Indonesia	55	Korea
25	Romania	56	Russian Federation
26	Czech Republic	58	Canada
28	Spain	60	Australia
29	Luxembourg	61	Saudi Arabia
31	India		

At the global level production of heat and electricity is essential for the formation of the total GHG emission volume – **energetics causes 1/4** of total GHG emissions worldwide

Energy technologies for energy production and transmission of energy for consumption promote implementation of technological solutions that reduce GHG concentration in the air

Direct GHG emissions of energetic technological equipment is carbon dioxide (CO₂), methane (CH₄) and nitrogen oxide (N₂O), while indirect – carbon monoxide (CO) and sulphur dioxide (SO₂)

CO₂ and CO gas emission are mostly formed from combustion of fossil fuels

Emissions of volatile fraction of fuel into the atmosphere can occur, that is not associated with the combustion process, e.g., leaching of CH₄ from natural gas pipelines or storage systems



Global GHG emissions by sector (years 1990-2010)

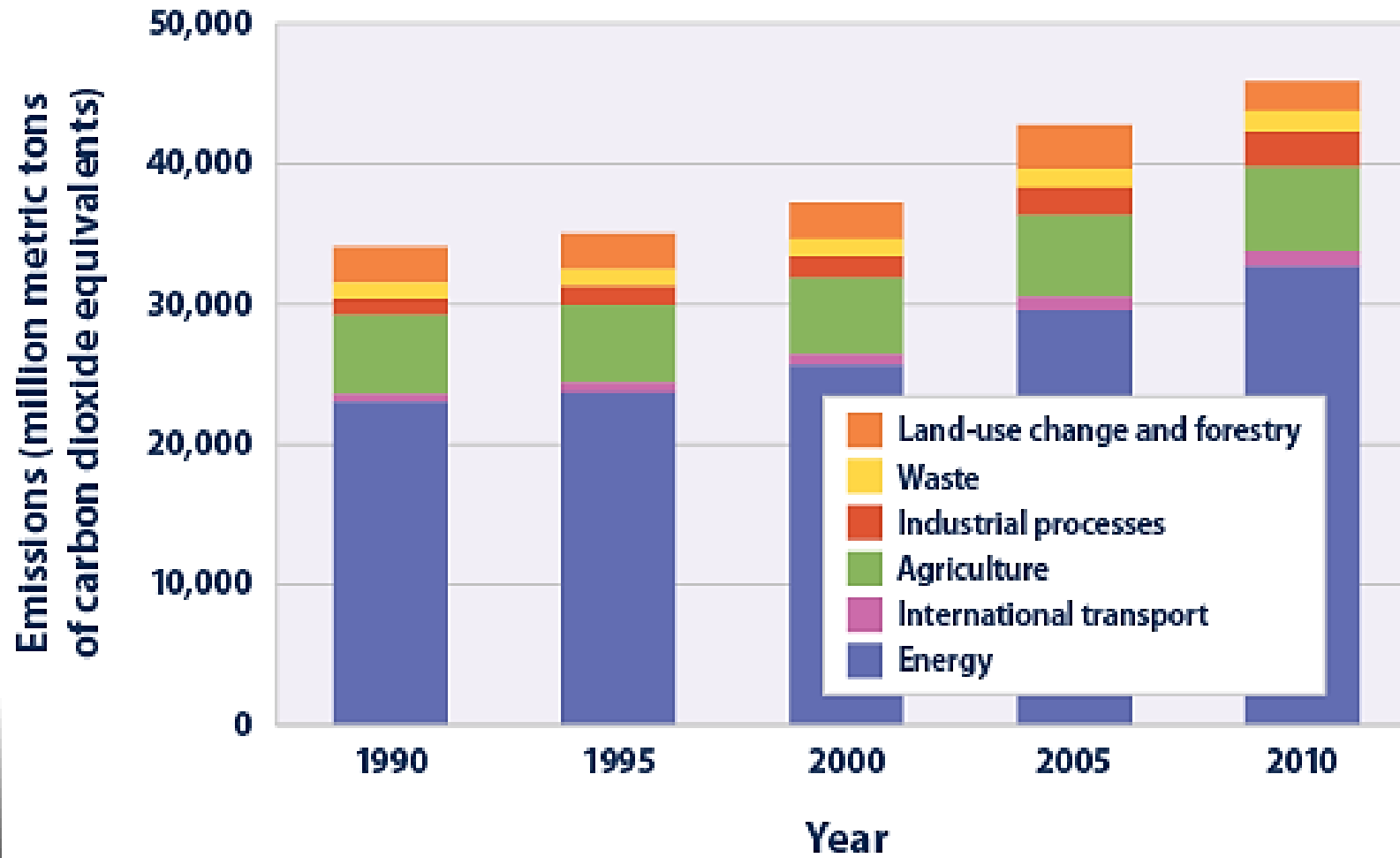

GHG emissions from the energy sector in the global level

GHG emissions from production of electricity and heat **25%**

Other GHG emissions **75%**

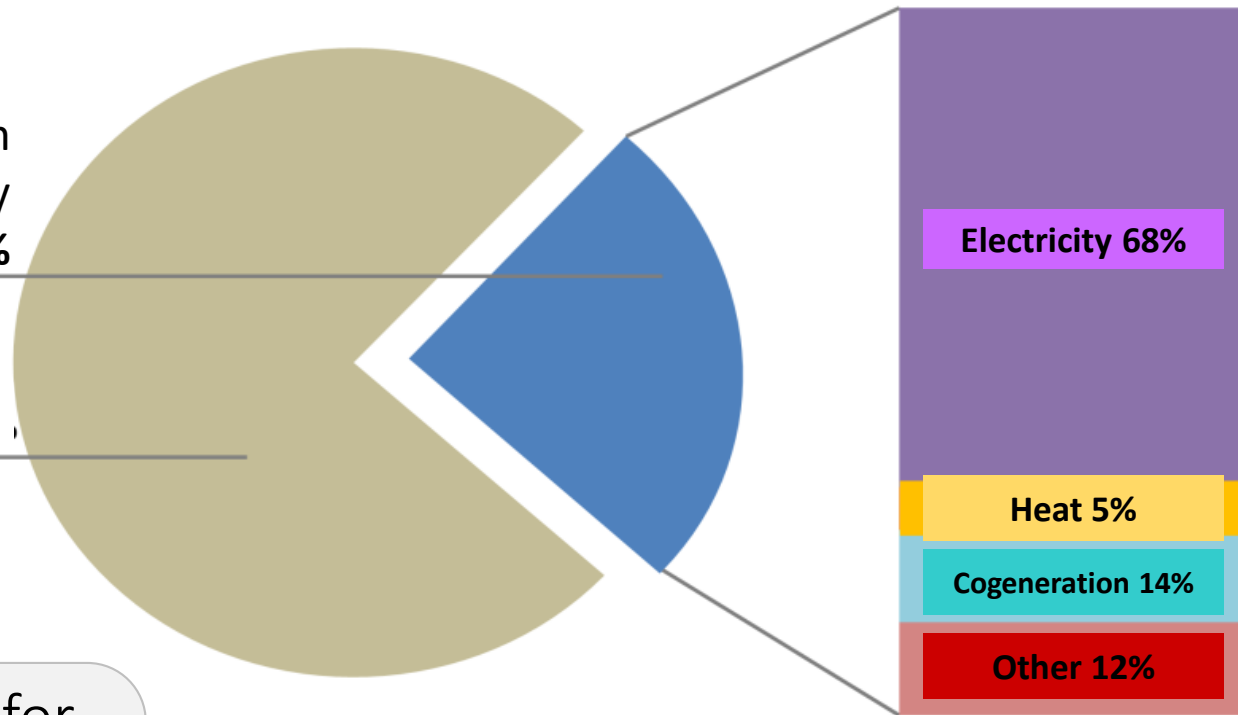

There are three real options for reducing CO₂ emissions into the atmosphere from energy technological facilities:

- **Increase the energy efficiency of existing technologies or by installing innovative and energy-efficient equipment instead**
- **Promote the use of renewable energy by replacing existing fossil fuel installations with alternative low-carbon energy technologies**
- **CO₂ underground storage**

All energy efficiency measures, regardless of the stage of energetics (generation, transmission, consumption) are considered as activities of climate technology implementation

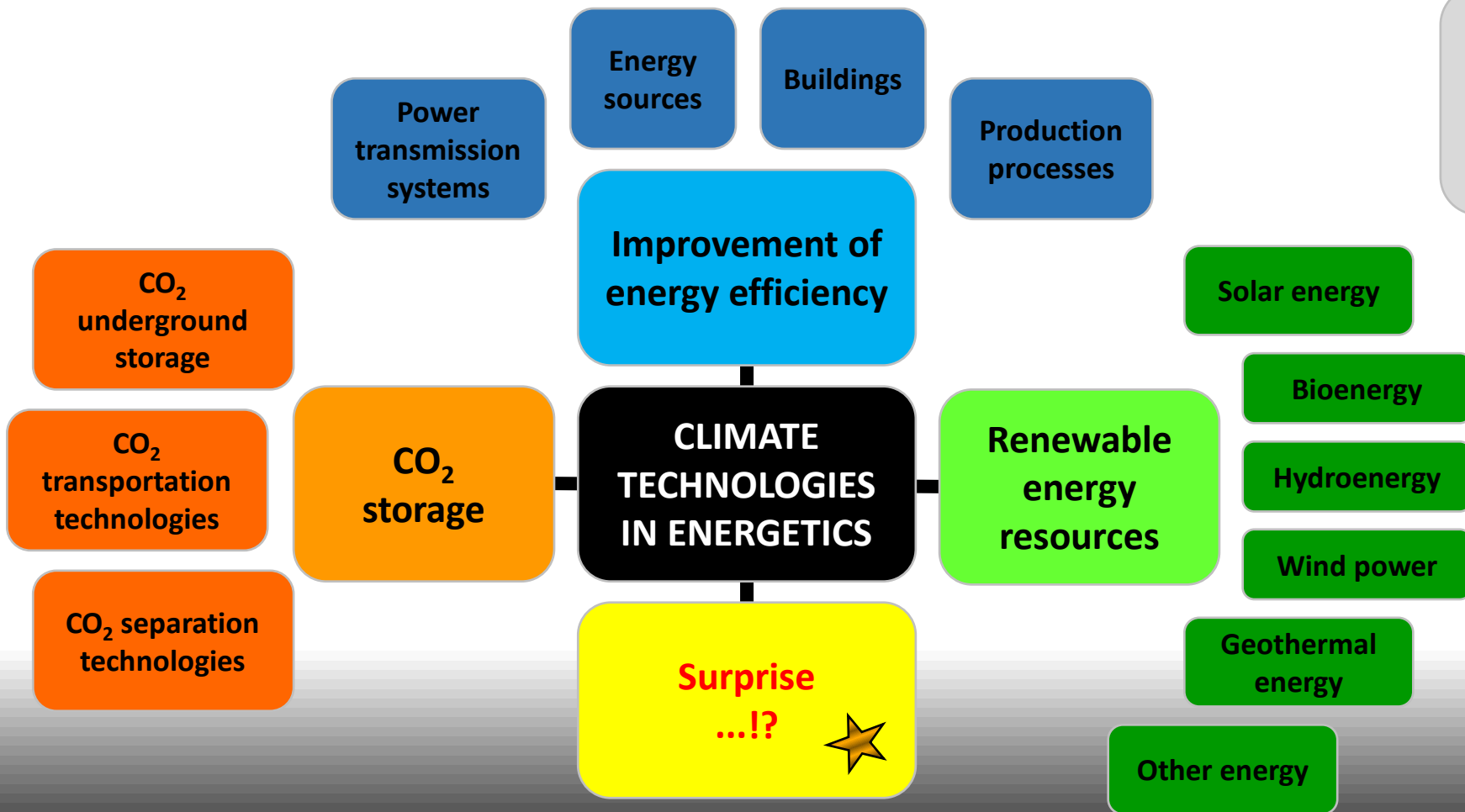

Considering rapid introduction of new technologies, sustainable climate technology creation and establishment can be predicted

★ One of the new directions of technologies is use of CO₂ for chemical reactions and biological processes

Thus CO₂ is not released into the atmosphere, but it becomes as a raw material in the economics

Example of climate technologies

- Heating system of Ludza municipality during the first restoration of Latvia independence years was the boiler house with a capacity of 40 MW
- It was operating with low efficiency (75%)
- Liquid fuels – fuel oil – were used

- Boiler house was reconstructed by installing water boilers with wood chips
- Optimal boiler output was selected 7 MW and backup boiler with a capacity of 3 MW, to be used during repair of the main boiler or in cold winters
- Fossil liquid fuel firebox made it possible to diversify energy resources

- Thus boiler house in Ludza significantly reduced fuel oil consumption, replacing it with renewable energy resources
- CO₂ emissions decreased to 17 000 t CO₂/a year

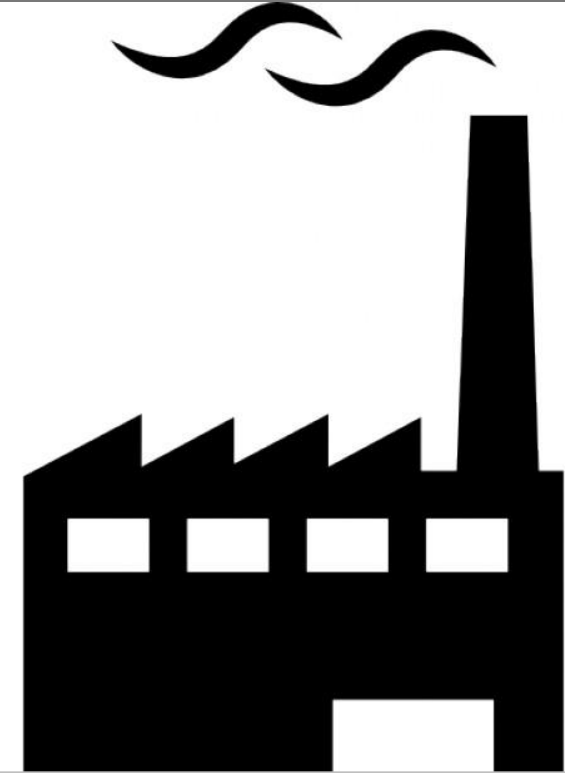



ENERGY CONSUMERS

Energy consumer is the one who determines what kind of energy is required at certain place and time, thus the power demand has not only the dimension of capacity and quality, but also spatial and temporal dimension

Demands of energy consumer and its changes significantly affect not only the development of energetics but also amount of GHG emissions that is released into the environment

Energy consumers are at least in five sectors of the economy:

- **In households mainly buildings consume energy**
- **In industry – mainly technological equipment and buildings**
- **Services consume energy mainly by the building, as well as office and household equipment**
- **In agriculture – buildings and equipment**
- **In transport sphere – vehicles**

Impact of energetics on climate change is mainly determined by **the energy consumer**

Consumer always have the opportunity to take energy efficiency measures to save energy and money as well as to reduce the impact of climate change

Demand of energy consumer for quality and capacity is estimated by both, energy consumption and its parameters, as well as by characteristics of a user and technological solutions

Energy management is an activity of energy consumer with the aim to reduce power consumption without compromising performance and comfort



Energy efficiency measures are various: ones are possible to realize with a small investment, but others need large investments

Professionals of energetics prefer the measures without a large initial investment, the implementation of which is related to the activities of energy management

Introduction of energy management in Latvia has made a possibility to gain excellent energy savings, at the same time revealing that we can become more environmentally and climate-friendly



The energy efficiency pyramid

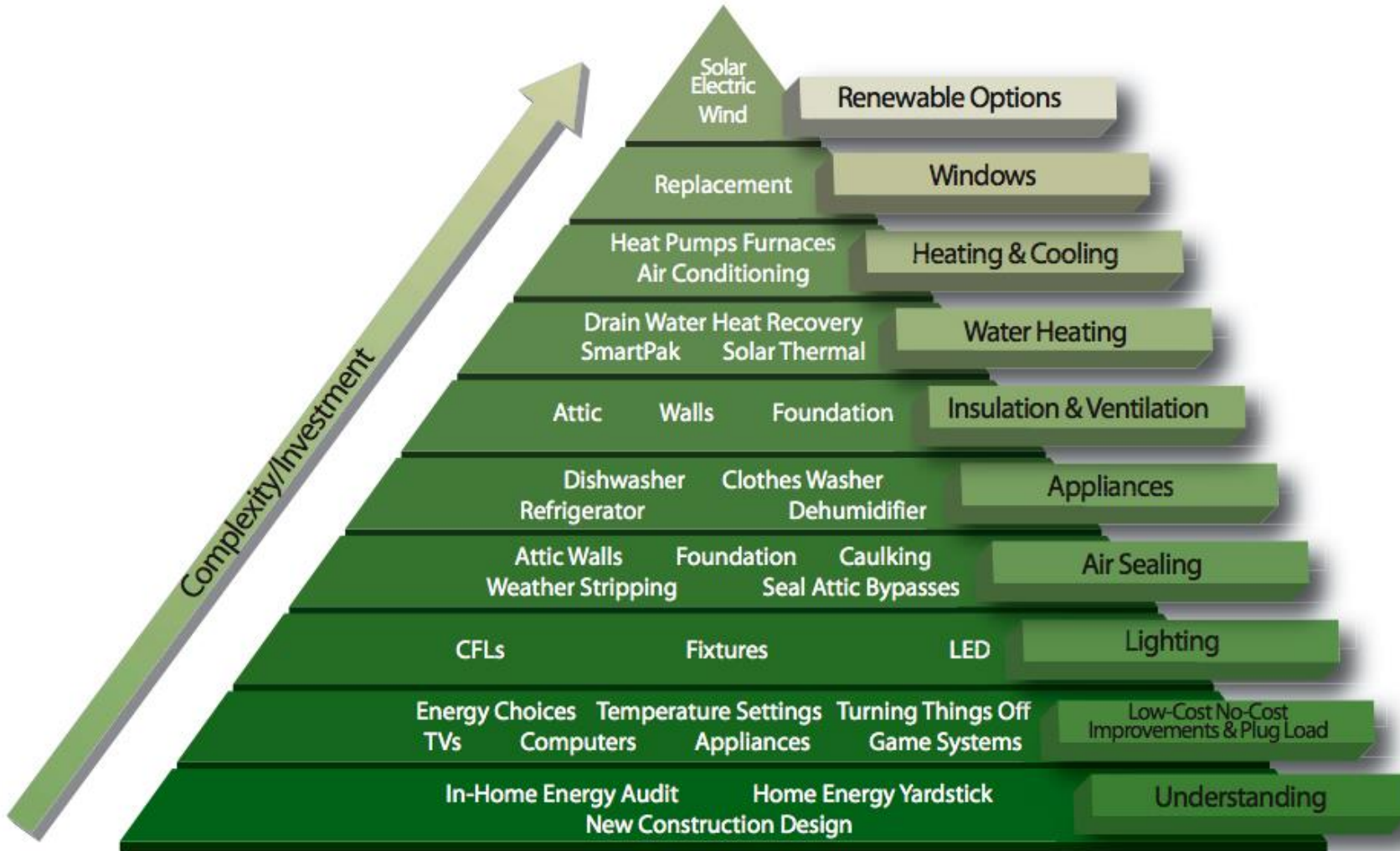

Energy consumers can be subdivided into three groups:

- **Those who associate energy efficiency with a simple factor «I will take a certain action and I will save money»** – it solves the problem only partially, because there are people for whom this is not an important factor in general or savings are relatively small
- **Those who always look at the action of neighbors or friends (hedonists) and they need to assert itself, outsmarting fellows** – it promotes competition, encouraging people to be more energy efficient in their daily lives than neighbors
- **Those who live «green» lifestyle** – for them environmental protection is important and they know how energy efficient lifestyle reduces environmental pollution and the impact of climate change



Implementation of climate technologies – examples of energy management



- **Apartment building in Rezekne, where, regarding active work of voluntary energy manager, without additional investment was achieved by 40% larger annual reduction in energy consumption**
- **In Liepaja, by municipal local government initiated energy management in buildings amounted to 20% annual energy savings**
- **A pellet manufacturer in Latvia with implementation of energy management reached 15% annual reduction in energy consumption**

Energy management of GHG emissions – a benchmark example

- Energy manager of a house completed data collection by recording energy consumption values and available information on wind speed, solar radiation and other relevant data every day at a certain hour
- Data assessment involved calculation of CO₂ emissions from a daily natural gas consumption

- If the daily recording point is located above the benchmark, it means that energy consumption is higher and influencing factors need to be evaluated
- It is possible to understand what happens in the building and how to decrease energy consumption, e.g., by regulation of heating system or closing windows etc.

- When the daily recording points regularly are located below the benchmark, it is possible to draw a new benchmark line and to assess reduced impact on climate change

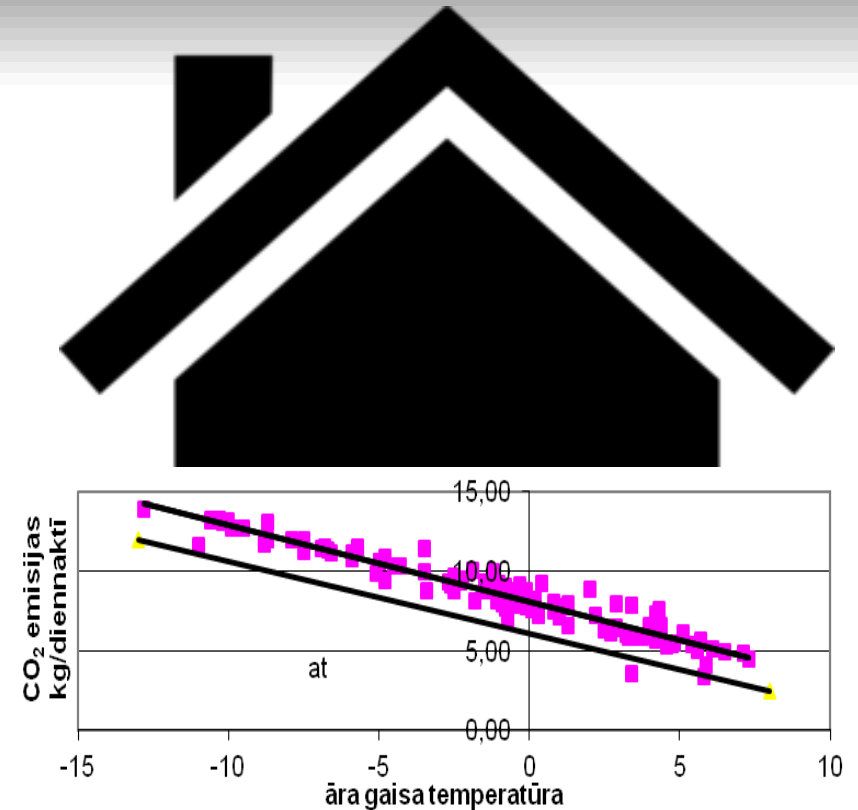

Climate technologies of energy consumers include all the equipment, devices and materials, which are used to reduce energy consumption

Distribution of CO₂ emissions in buildings

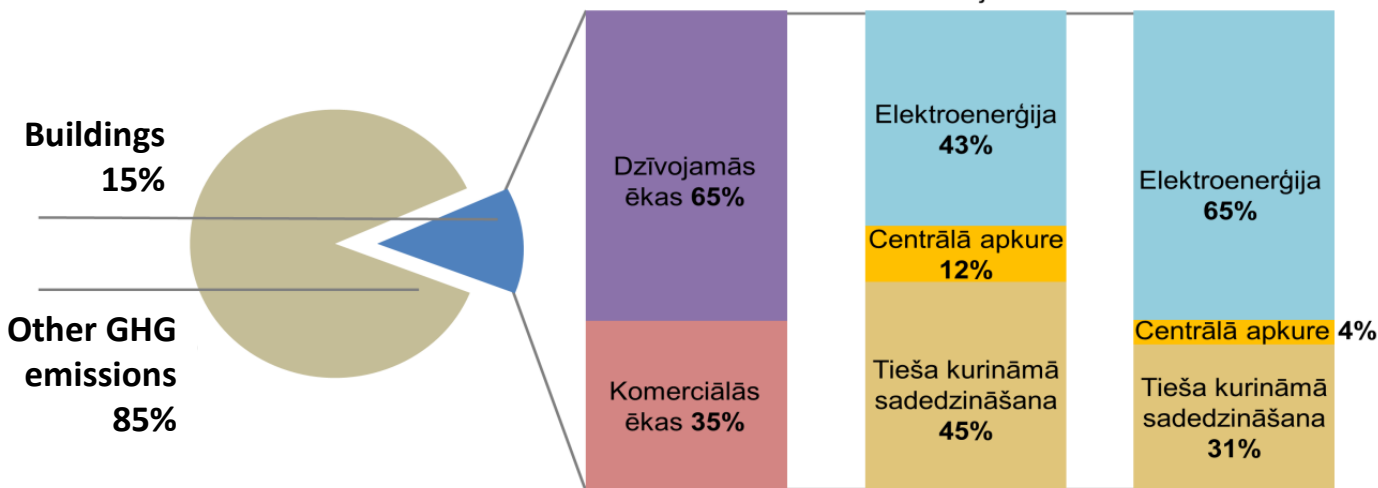

Building as an energy consumer affect climate change – buildings account for 1/7 of the total GHG emissions worldwide

At present, not only in Europe but also in Latvia the greatest energy consumers are households, accounting for 35% of total energy consumption

Heat consumption of a building depends on various factors: climate, building location and orientation, physical characteristics of the housing, equipment and system efficiency, behavior of the owner and residents

Building energy consumption and environmental impact is determined by **technical characteristics of a building** (shape and volume, materials, constructive solutions, air permeability etc.) and by **building functions** (maintained microclimate, duration of use, equipment and building activities etc.)

Climate technology usage in buildings has recently developed not only into building energy efficiency measures, but also on regional planning and environmental landscaping level

By insulating buildings, it will not only reduce heat consumption, but also acquire a new image, increased property value and at the same time building residents have the opportunity to live in an orderly environment

One of the solutions is «**embodying**» of **old industrial buildings** arranging them for new activities, e.g., in European cities old gas storages are transformed into concert halls, exclusive apartment houses, hotels etc.



Use of buildings in Stockholm,
territory of Gasworks

The building heat consumption indicator (specific annual heat consumption per 1 m² of heated area expressed as kWh/m² per year) is used for distribution of buildings in four groups:

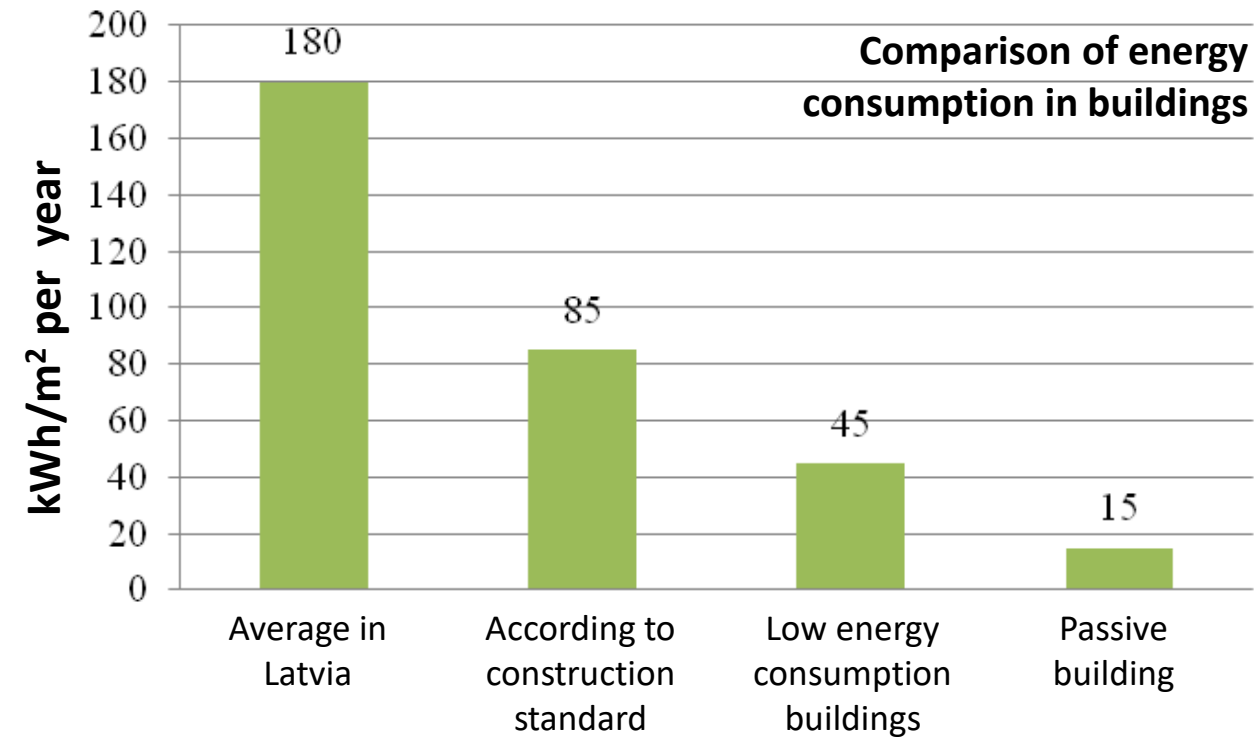

- Buildings with low energy efficiency which consume more than 85 kWh/m² per year
- Buildings corresponding to the construction standard LBN 0902 01 which consume 85 kWh/m² or less per year
- Low energy consumption buildings which consume 45 kWh/m² or less per year
- Passive buildings which consume 15 kWh/m² or less per year

In practice it is revealed that specific heat consumption in industrial buildings in Latvia is high due to the fact that production technologies frequently are located in old plants adapted for the manufacture of new products and the building area is larger than it is necessary

Wide range of **power using climate technologies in buildings** in all groups of electrical equipment can be subdivided:

- **Lighting technologies:** light-emitting diodes, or LED lamps drastically reduces the power consumption of the lighting provision

- **Household electrical devices:** each year, science-based innovations provide new climate technology solutions, e.g., A+++ class label on a fridge indicates that the annual electricity consumption has reduced from 500 kWh/year (A+) to 170 kWh/year (A+++)

- **Office electrical equipment:** computers, monitors, copy machines, servers and other electrical equipment have substantially changed over the years, into direction of the power consumption reduction

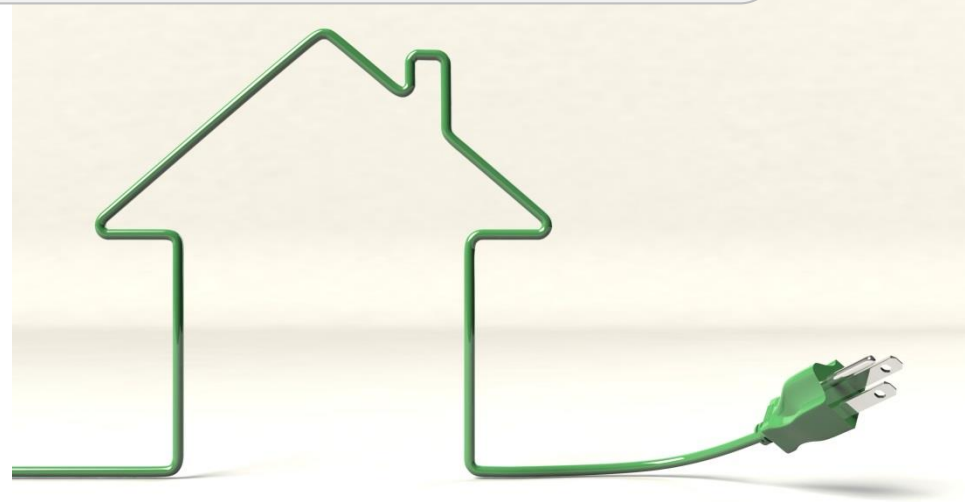

- **Heat pumps now can replace electrical heating systems** – from the point of view of GHG emission reduction, the future of heat pumps is related to the moment when the electricity gained from fossil fuel will be replaced by electricity from renewable resources (biomass, solar, wind)
- **For electrical engines,** that are installed as a power equipment of pumps, fans and other devices, the most useful detail in reduction of GHG emissions is a frequency converter, which reduces the power consumption by decreasing loads

In production processes at industrial enterprises three types of climate technologies' equipment is used:

- **Combustion equipment**
- **Heat production equipment**
- **Electricity supplied equipment**

The highest GHG emissions are released from combustion equipment: boilers, kilns, furnaces etc.

Reduction of GHG emissions is possible:

- **For electrical power supplied equipment** – electrical heaters, ovens, refrigeration devices, mills, pumps, transport equipment etc. – by focusing on implementation of the best available technological solutions in each industrial field
- **For heat power supplied equipment** – heat exchangers, autoclaves, baths, hot water and ventilation systems etc. – by introducing more modern and energy efficient technologies
- **For combustion equipment** – by replacing fossil fuels with bioenergy resources as well as by increasing the device's efficiency during the operation time

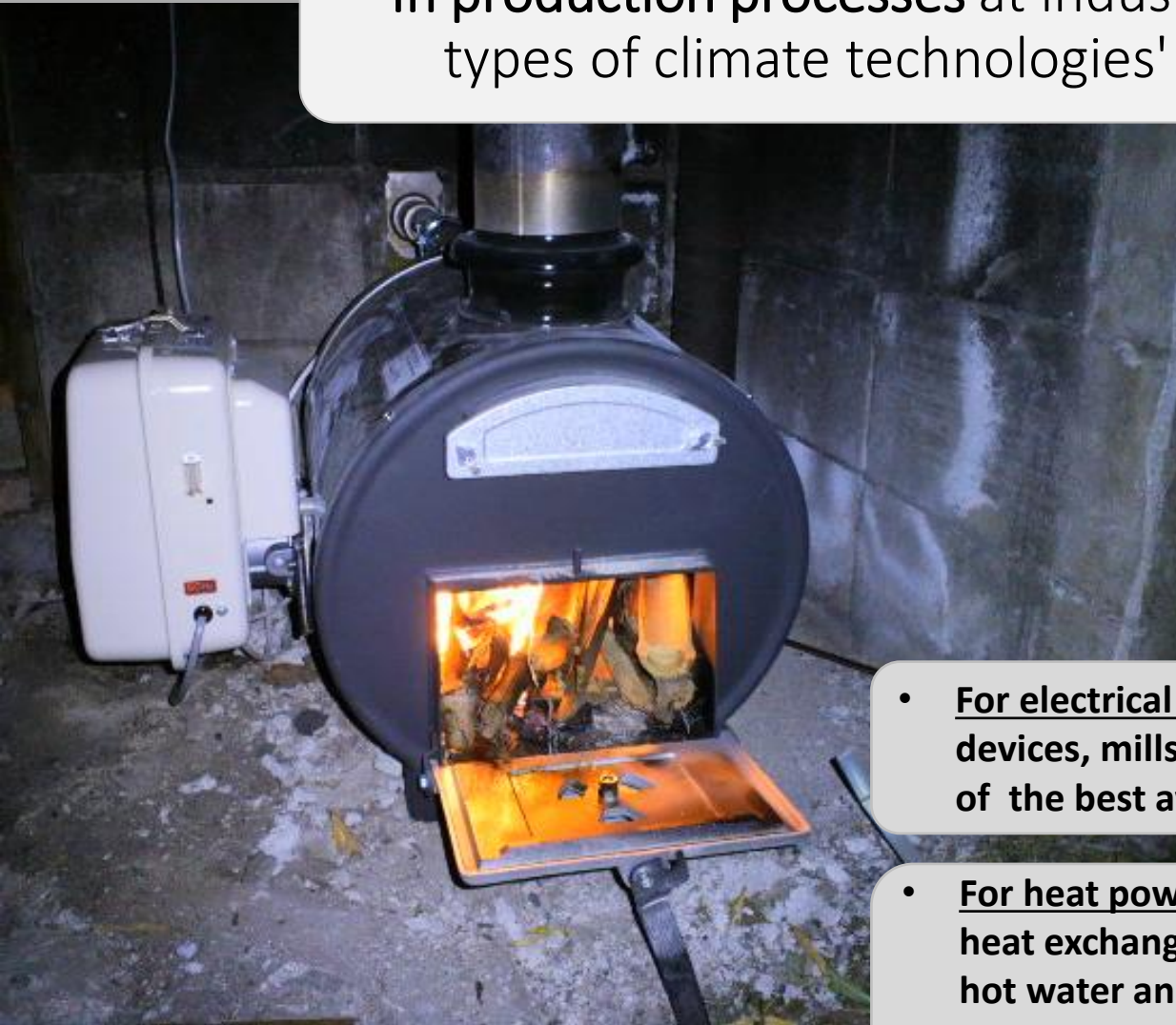

TECHNOLOGIES OF RENEWABLE ENERGY RESOURCES

All renewable energy technologies are climate technologies, because their use does not affect climate change - GHG emissions from these technologies, including biomass combustion technologies, are equal to zero

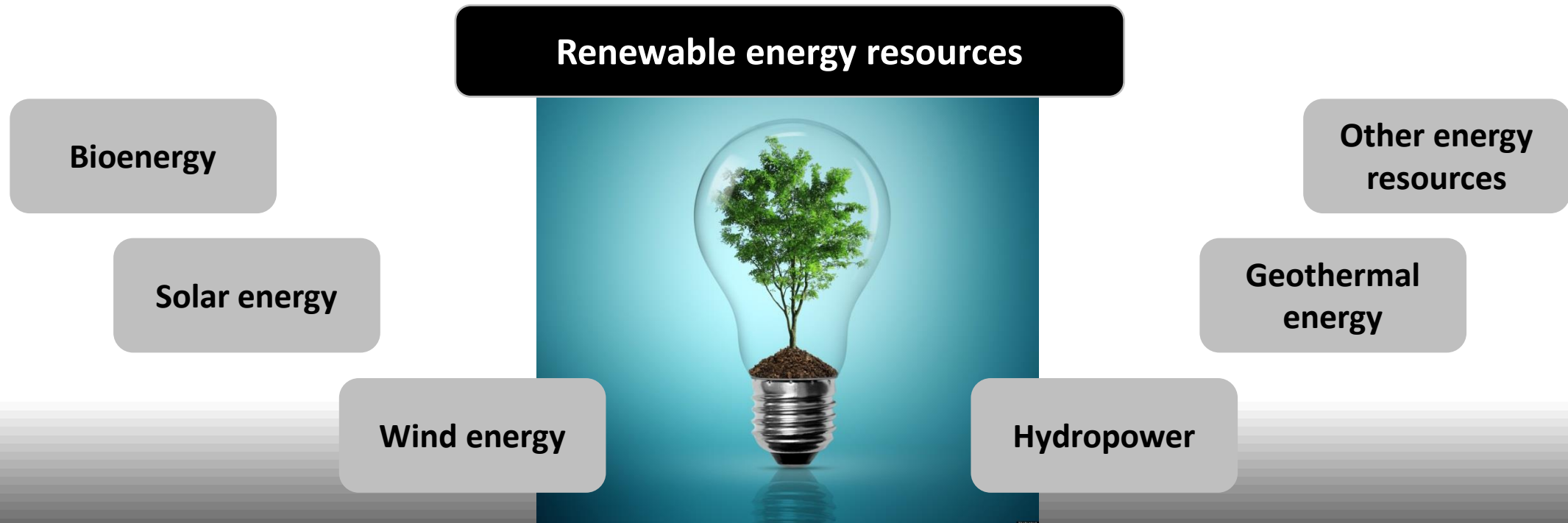

The concept of **bioenergy** includes a wide range of bioenergy resources:

Starting from various types of biomass waste such as biodegradable fraction of industrial, municipal and agricultural waste and forestry residues, gases from landfills and sewage treatment plants and ending with biogas

The cube of bioenergy production and use includes:

- Sources of bioresources (upper pane)
- Processing technologies of bioresources (side pane)
- Type of energy consumers (front pane)

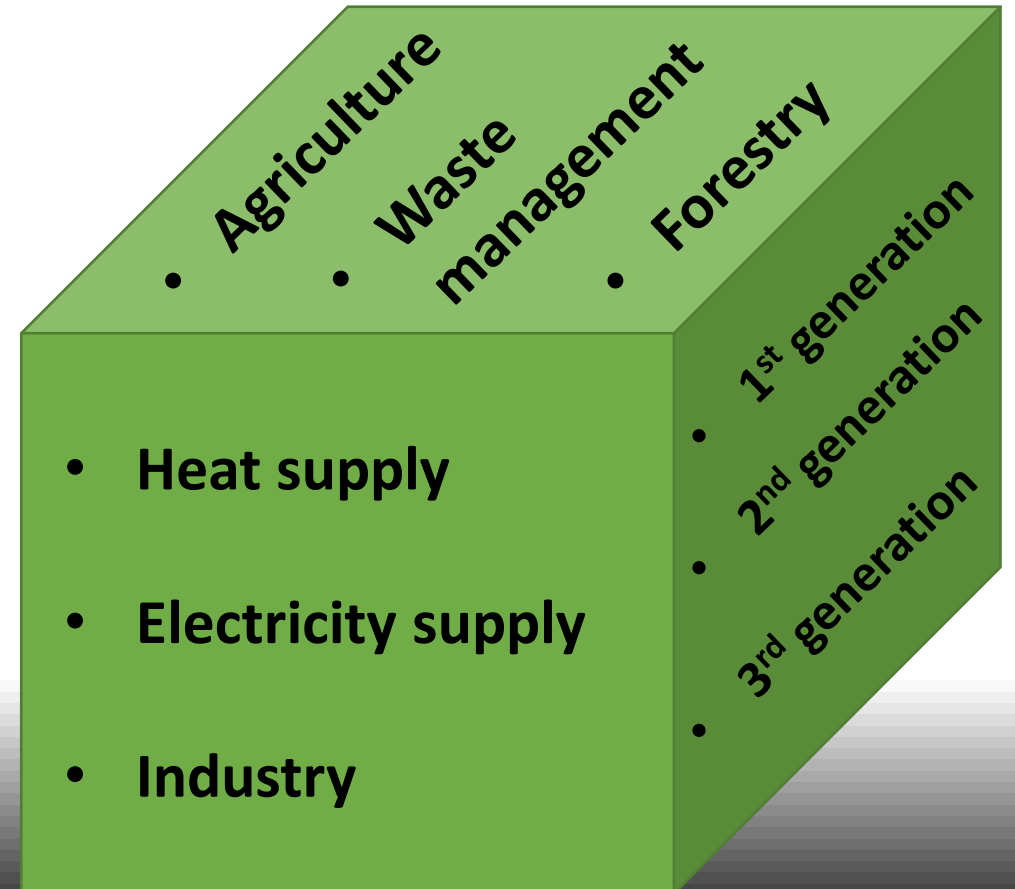

Bioenergy is derived from biological sources – both, plant products such as trees, shrubs, cereals, reed, algae, and animal products such as fat, waste



Biomass is a matter that is mainly composed of carbon, hydrogen, oxygen and nitrogen

Bioenergy as a renewable energy accounts for provision of 10-15% of the world's primary energy demands

Plant biomass consists of three main components – cellulose, hemicellulose and lignin – which vary by different types of plant biomass

Cellulose and hemicellulose are the reinforcing fibers of biomass structure, but lignin is binding these fibers together

As a biomass also by-products such as agricultural crops, forest raw materials, solid urban waste, manure, sludge can be assessed

Bioenergy resources are classified using a variety of criteria - by their origin, composition (depending on the components of biomass) or by possibilities of use

The term «lignocellulosic biomass» is often used to describe fibrous materials consisting mainly of cellulose and lignin which are bound in uniform structure

This type of biomass contain low concentration of proteins, salts, acids and minerals, thus, it is unsuitable for use as a raw material for feed or food production of agricultural origin

Cellulose is a polymer of glucose molecules that forms the basic structure of the biomass - it is the largest component of the biomass in comparison with other components

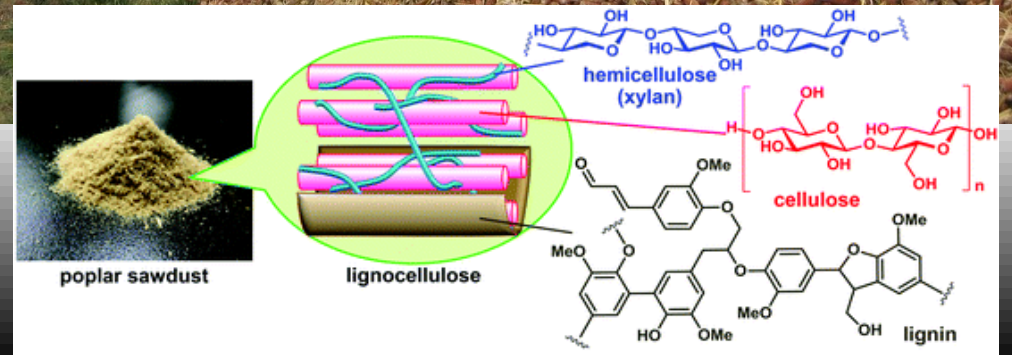

In production of lignocellulosic biomass three more major components have to be assessed:

- **Ash**
- **Extractives**
- **Water**

- **Ash is a hard remain resulting from biomass combustion – completely burned ash do not contain Ca and H**
- **Ash slightly contain compounds of N, S or O and contain primarily mineral matter of biomass as various compounds of Al, Mg, Na or K**

- **Extractives contain mainly fatty acids, fatty substances, phenols, salts etc.**
- **Amount of extractives often in biomass composition is very low, and still they have not been much investigated**

The main sources of lignocellulosic biomass:

- **Agricultural products**
- **Forestry products**
- **Energy crops**
- **Organic waste**

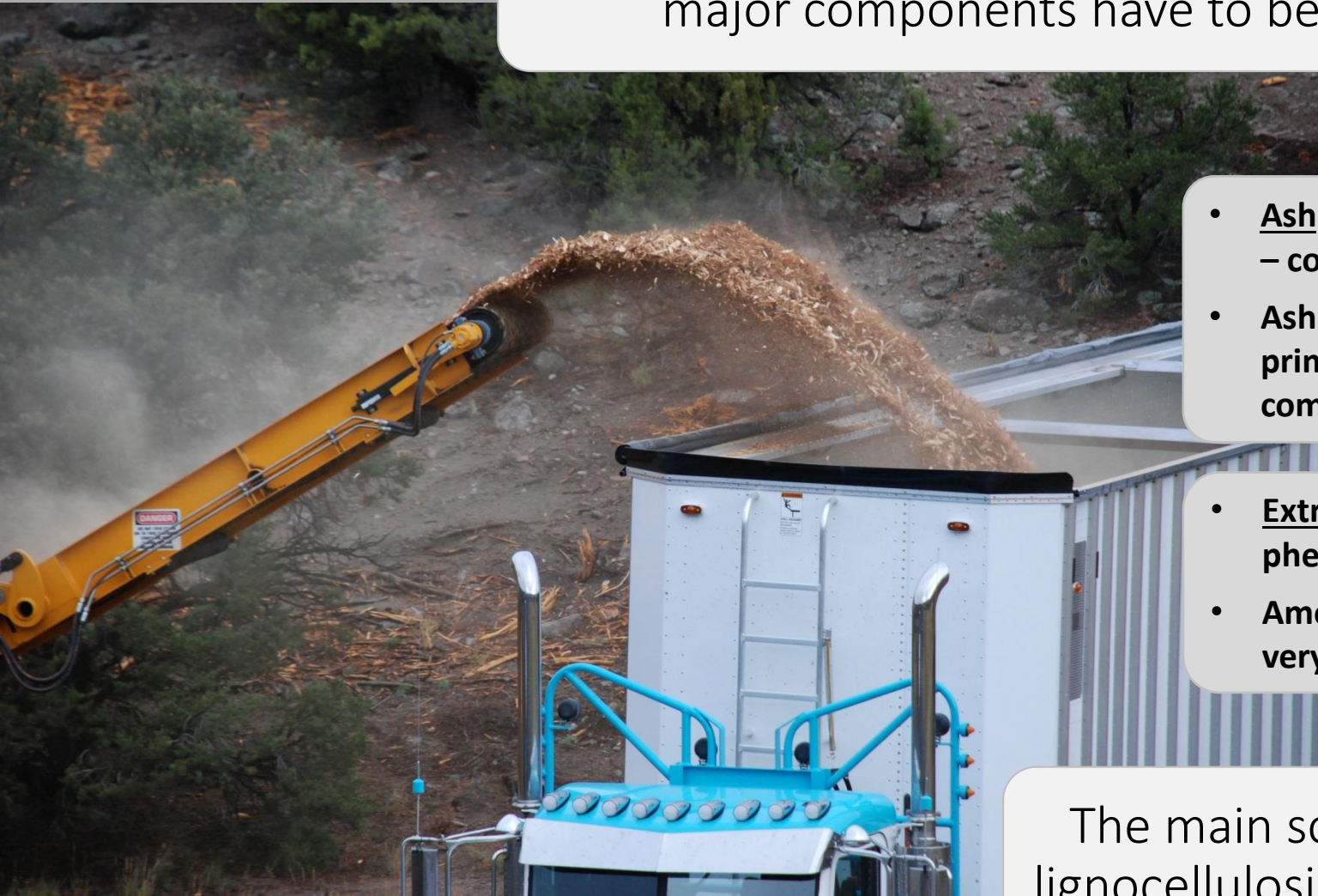

Classification of bioenergy resources:

1. **The 1st generation's bioenergy resources include biomass derived from agricultural crops traditionally grown for human consumption and animal feed**

Usually from this biomass liquid and gaseous biofuels are derived

The main products currently available on the world market are: bioethanol, biobutanol, biodiesel and biomethane

2. **The 2nd generation's bioenergy resources are raw material which can not be directly used in food production**

This is lignocellulosic biomass which includes, for example, energy wood, fast-growing shrubs, leaves, grass, straw

Cultivation requires less land, and access to these resources of is ensured throughout the year depending on location

3. **The 3rd generation's biofuel is derived from types of biomass which do not compete with the food and fiber sector, for example, algae are used**

Algae have rapid weight gain power; it is not necessary to use cultivated areas or water of high quality to produce algae

Currently, a rapid development of the 3rd generation's bioenergy resources is going on as biofuels of the 2nd generation are not the only way to replace use of fossil fuels and avoid competition with the food sector

Processing of bioenergy resources results in products that are used in various sectors of the economy: energy, transport, households, services, industry and agriculture

Technological products of bioenergy resources' processing can be classified due to variety of signs: by the physical state and physical or chemical properties of the product, by the source of the product, as well as by the possibilities of its use

1) **Solid biomass for production of technological products, e.g., in lime firing process**

- Wood chips, briquettes and pellets, firewood
- Straw, straw pellets
- Waste such as used tires, waste derived fuel
- Charcoal

2) **Gaseous substances for the production of electricity and heat in cogeneration plants, power plants, boiler houses and vehicles**

- Biogas
- Synthesis gas

3) **Liquid fuel for vehicles or heat and electricity production and cogeneration plants**

- Biodiesel
- Bioethanol
- Biobutanol



Biogas production technological equipment set is a single system which includes:



- **A variety of sources of raw materials (manure, organic waste and sometimes green biomass such as corn)**
- **Biogas reactors**
- **Biogas reservoirs**
- **Digestate block**
- **Installations for energy production from biogas**

A by-product from biogas production is digestate (processing substrate) which can be used as a soil fertilizer

Anaerobic fermentation process produces little amount of heat, unlike during the anaerobic decomposition (in presence of oxygen) such a composting is

Chemical energy of the substrate mainly remains in the produced biogas as a methane

An example: agricultural co-fermentation biogas plant using manure and maize silage

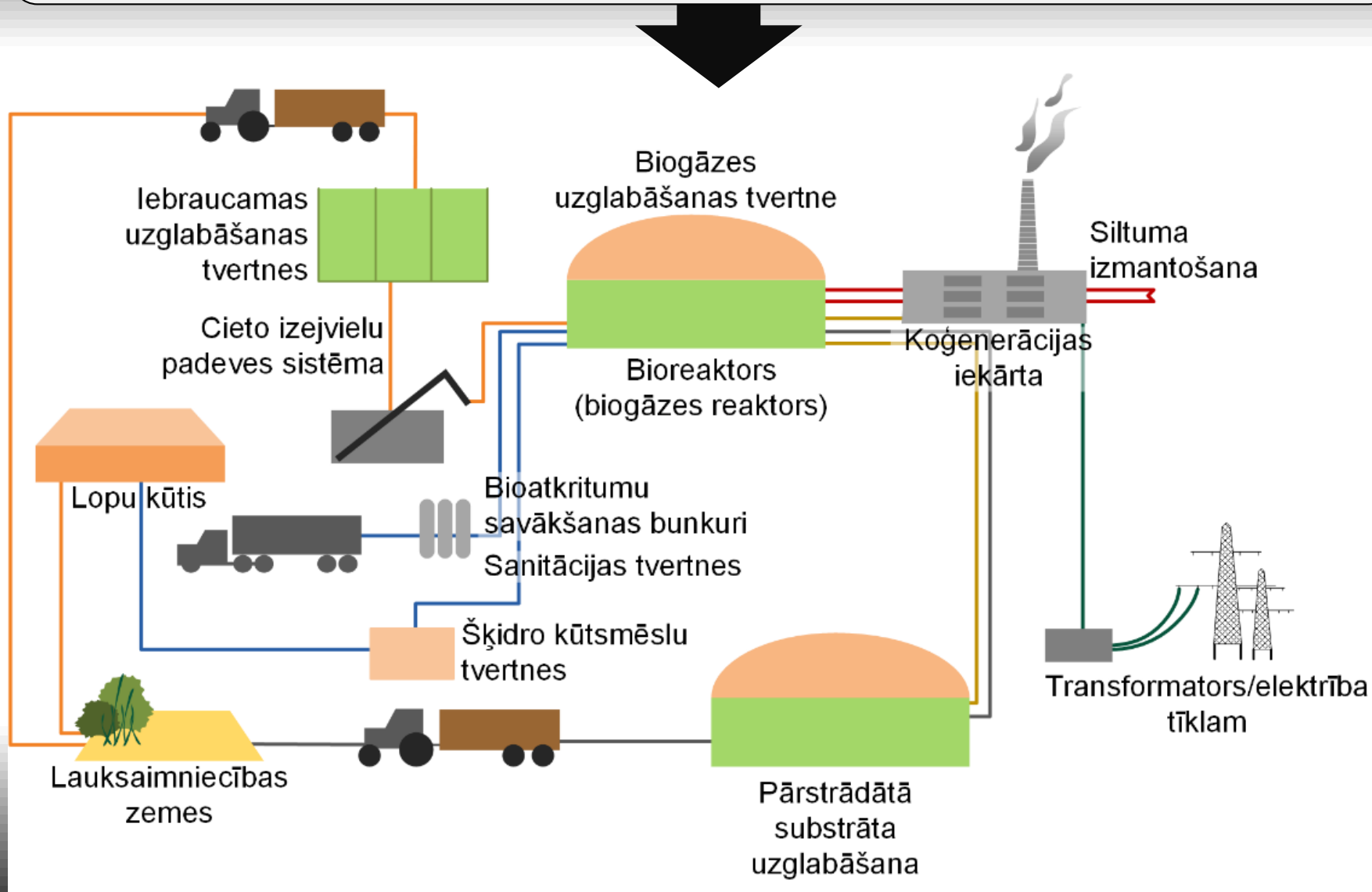

1. Livestock sheds
2. Liquid manure storage
3. Biowaste collection containers
4. Sanitation containers
5. Portable storage containers
6. Bioreactor
7. Biogas storage tank
8. Cogeneration plant
9. Digestate storage tank
10. Agricultural land
11. Electricity transformer
12. Heat consumer

In order to provide consumers with the necessary energy, into energy sources **energy technologies** are installed in which chemical energy is converted into the thermal energy, and it should be performed by minimum energy loss

Energy technologies installed in energy sources of bioenergy differ by a constructive mode of power and energy carriers as well as by the operating parameters

A key component of bioenergy technologies is the **firebox (combustion chamber)** where the combustion process occurs:

- **Ovens** (both, individual and industrial)
- **Fireplaces** (individual small heat sources)
- **Boilers** (both, individual and a large systems of heat sources)
- **Engines** (both, individual and a large systems of power supplies for production of electricity and heat)
- **Gas turbines** (usually high energy power supplies)

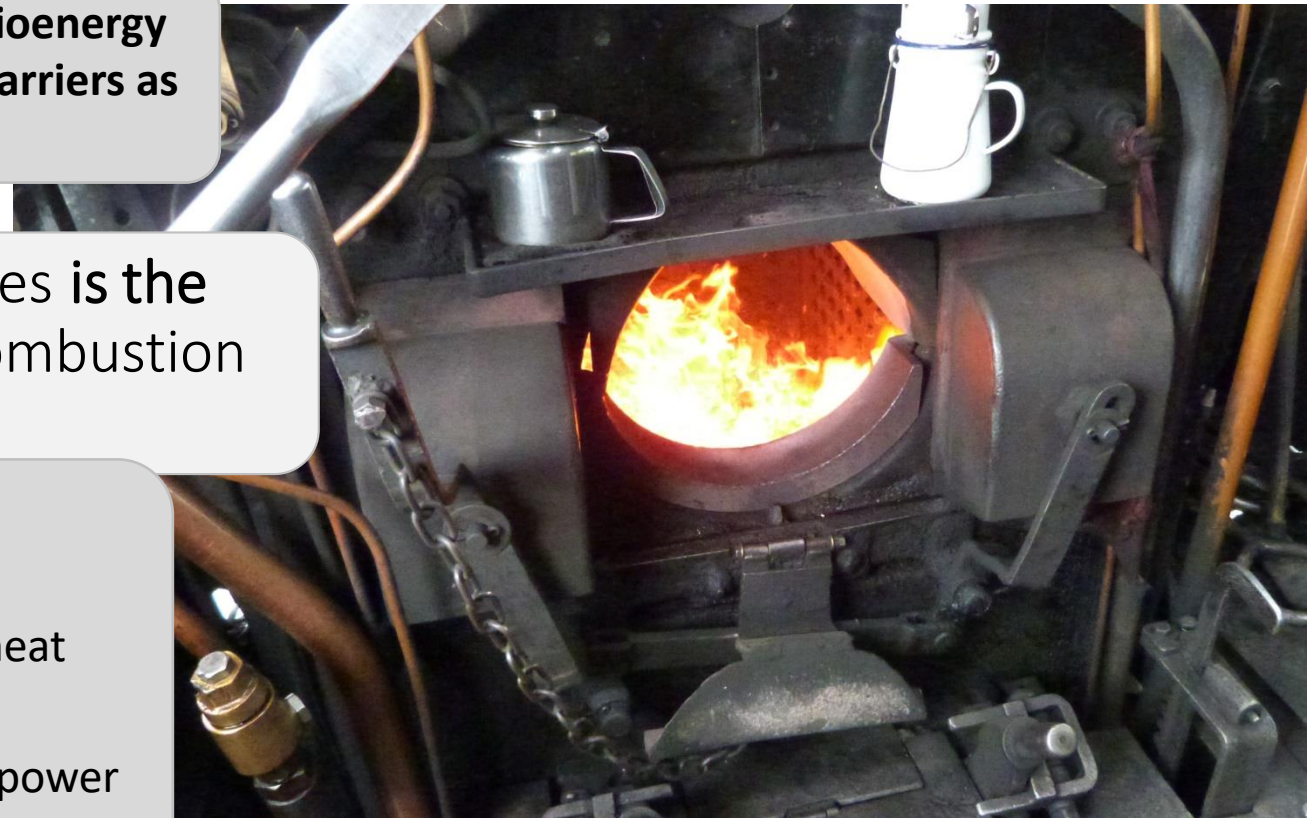

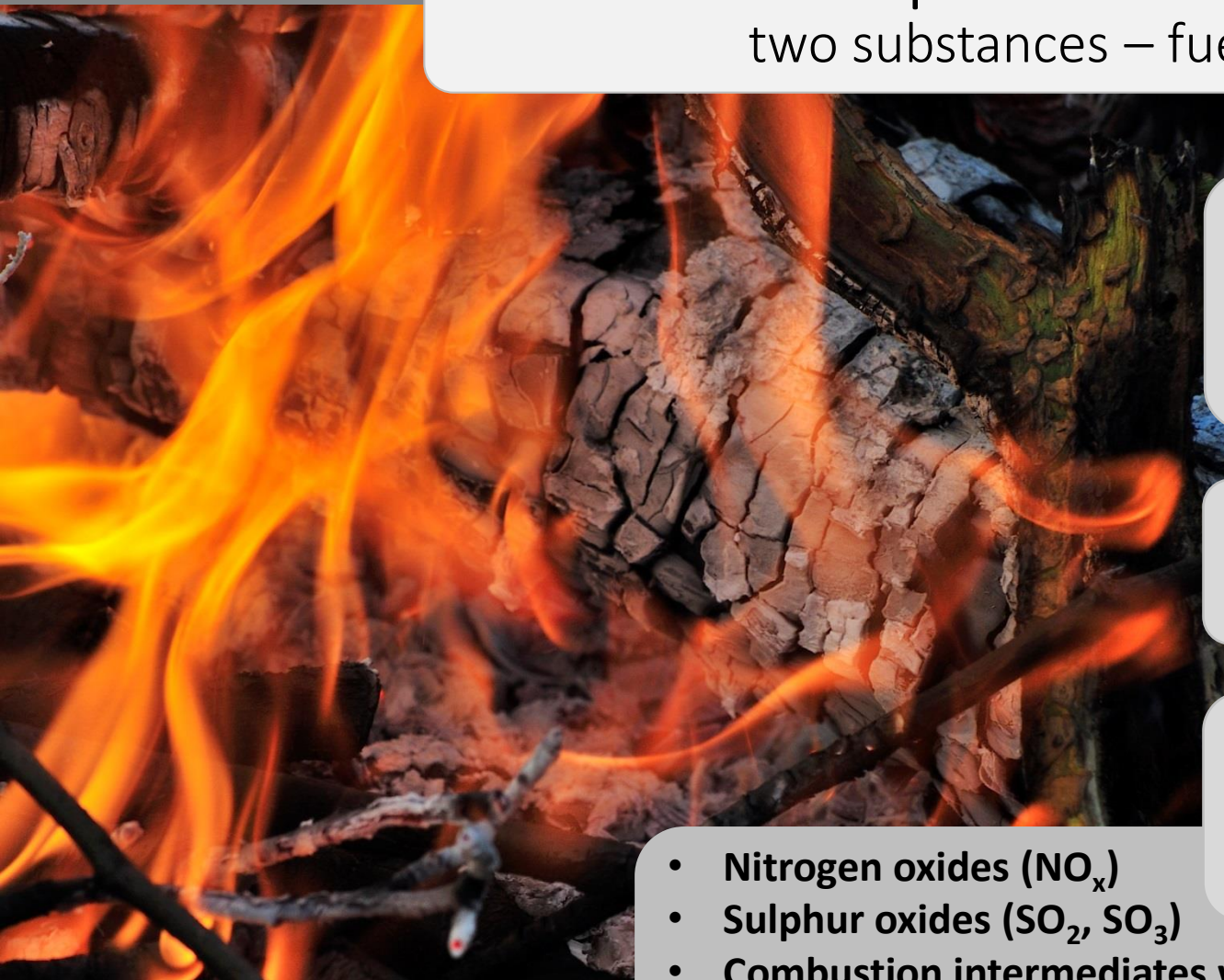

In fuel combustion process a chemical reaction is provided by two substances – fuel and air oxygen

Fuel properties, aggregative state, grain size and shape are different, therefore, oxygen access to the burning elements should be supplied at necessary proportions to ensure the complete combustion of any fuel

It is important to ensure that the flue gas contains only the complete combustion product CO_2 and water vapor, without ashes

During the combustion process, at the same time about 250 chemical reactions are taking place and, therefore, the combustion products may contain environmentally harmful emissions

- Nitrogen oxides (NO_x)
- Sulphur oxides (SO_2 , SO_3)
- Combustion intermediates which are formed during incomplete combustion (CO , C_mH_n , aldehydes etc.)

Depending on the source of energy type produced and supplied for consumers of energy, the power supply systems of bioenergy sources are divided into two large groups

Boiler houses are the energy source for heat production using any type of bioenergy resources



Boiler house in Liepaja

Co-generation plants are the energy source for the simultaneous production of electricity and heat, mainly using two types of bioenergy resources: solid biomass and biogas



Biogas and co-generation plant near Limbazi

Boiler houses is the most common heat source in Latvia; their technological solutions involve different sets of equipment associated with the combustion process organization and heat- and mass-transfer process implementation

Equipment installed in boiler houses involves devices of three groups:

- **Combustion technology** (furnaces with fuel supply and ash removal lust) – central part of the energy source
- **Boiler heating surface** (irradiation, convection and condensation surface) performs functions of the system that supplies the energy needed
- **Auxiliary equipment** (pumps, fans, smoke exhausters, biofuel supplies, water treatment and flue gas treatment plants)



SIA «Liepājas enerģija» biomasas katlu māja

In Latvia more than 50 energy-efficient biomass boiler houses are built, which are equipped with wood chips boilers and they produce heat in municipalities of Balvi, Cesis, Ludza, Tukums, Ventspils, Salaspils, Riga etc.

Wood chips boiler house in Ludza: flue gas condenser drawing and construction

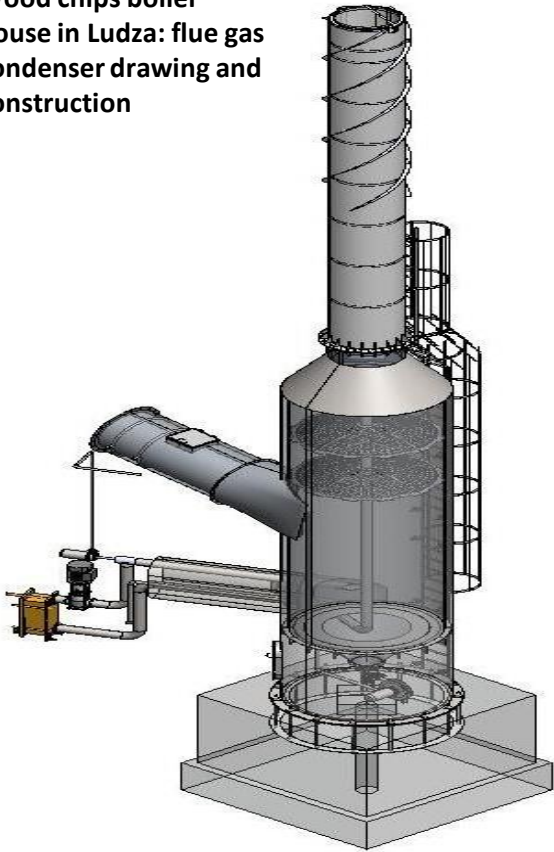

Implementation of scientific innovations at wood chips boiler houses allows to increase the energy efficiency of the energy source

For example, boiler houses in Tukums and Ludza, in collaboration Riga Technical University, have installed the flue gas condensers, leading to increased energy efficiency by 15-20%

Co-generation (combined heat and electricity power production) is an important tool in energy efficiency development to be secured for energy users' needs for heat, cold, electrical or mechanical energy

Co-generation using chemical energy of biofuel produces heat, which usually is transferred into electricity

Advantages of co-generation as a type of energy production are assessed in comparison with traditional forms of separate energy production: heat production in boiler houses, electricity production in power plants

Technologically it is possible that the energy is produced in co-generation with lower fuel consumption, and it means also higher energy efficiency



Climate technologies for co-generation plants refers to the «**high efficiency co-generation**» because following conditions are provided:

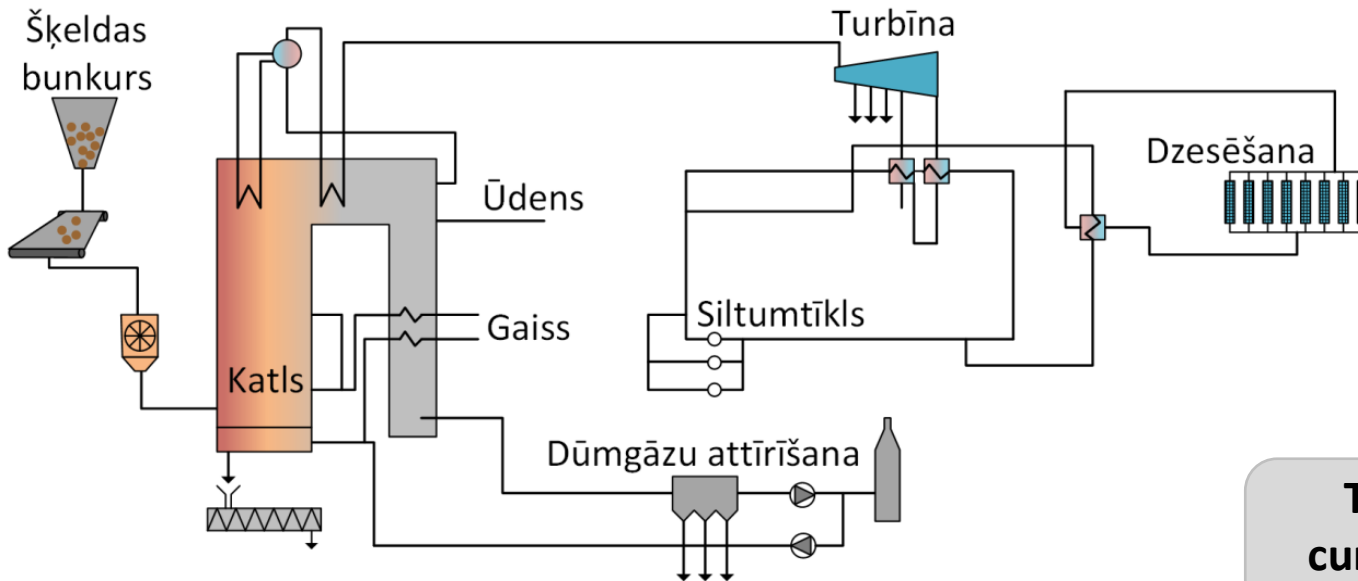

Technological scheme of the biomass co-generation plant in Jelgava

- **Primary energy savings of at least 10% in comparison to separate heat and electricity production**

- **Primary energy savings in small-scale and micro-scale co-generation versus separate heat and power production**

The largest biomass co-generation plant in Latvia is currently operating in Jelgava - it is located in an urban environment and near heat consumers

Electricity and heat production in biomass co-generation plant with high energy efficiency at present is considered as the most modern, environmentally friendly and most effective climate technology in field of bioenergetics

Use of solar power is the type of climate technologies, since the production of energy replaces fossil fuel consumption – these are GHG-neutral energy technologies

Long-term monitoring and data processing in Europe shows that in Latvia potential amount of used annual solar radiation is 1100 kWh/m² per year (in Nordic countries it is slightly lower)

However, the use of solar energy in Scandinavian countries are currently ahead of Latvia: not just by installing individual small-scale solar equipment, but also by building a large solar collectors or solar panel fields

Preferable utilization of solar power is associated with the storage of energy - it is one of the most important phases of solar energy technological systems





Solar energy technologies differ mainly by produced energy:

- Production of electricity using solar panels or photovoltaic cells, or solar cells
- Production of heat using solar collectors
- Combined systems – solar cells are used in combination with solar collectors; solar cells are used to power the circulation pump of solar collectors

Integration of solar collector systems in the district's heating system

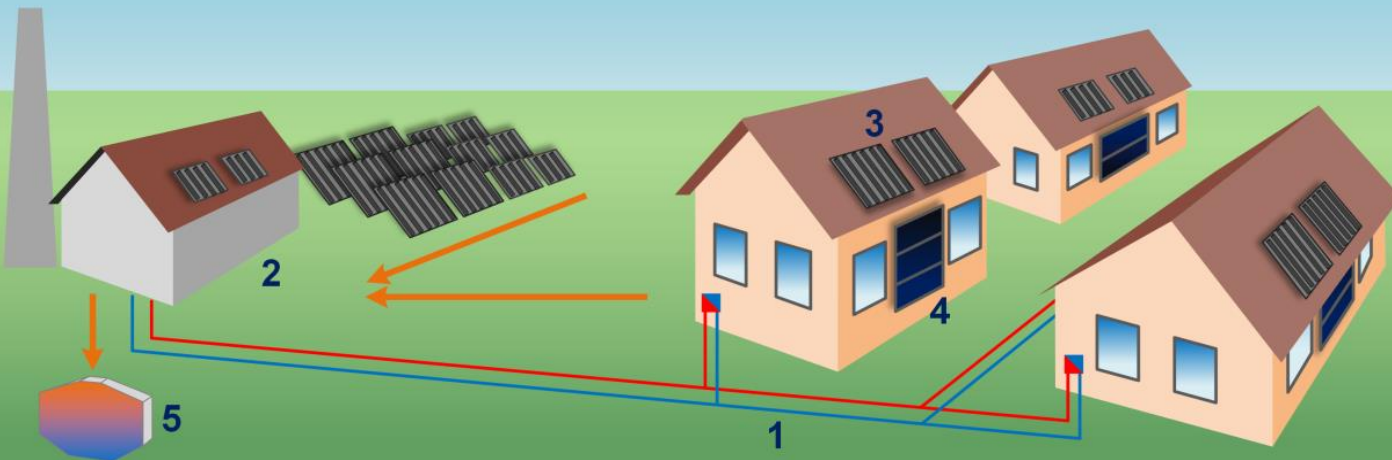

Currently four types of solar collectors are being used with different modes of solar energy absorbing surface structures:

1. **Volume collectors** – tanks with solar energy absorbing surface
2. **Flat collectors** – plates of absorption surface formed from different materials or coatings
3. **Pipe collectors** – absorbing surface formed from glass or other material tubes with different coatings
4. **Concentrating collectors** – solar energy concentration, made from a variety of high-temperature-resistant materials and coatings



Research in this area is developing to direction of improvement solar energy efficiency, searching for new solar energy absorbing surface material and coatings

Seasonal storage methods of solar heat makes it possible to use two different principles: up-underground storages or deep underground reservoirs

Seasonal storage methods of solar heat:
A and D – underground reservoirs; B and C – up-underground storages

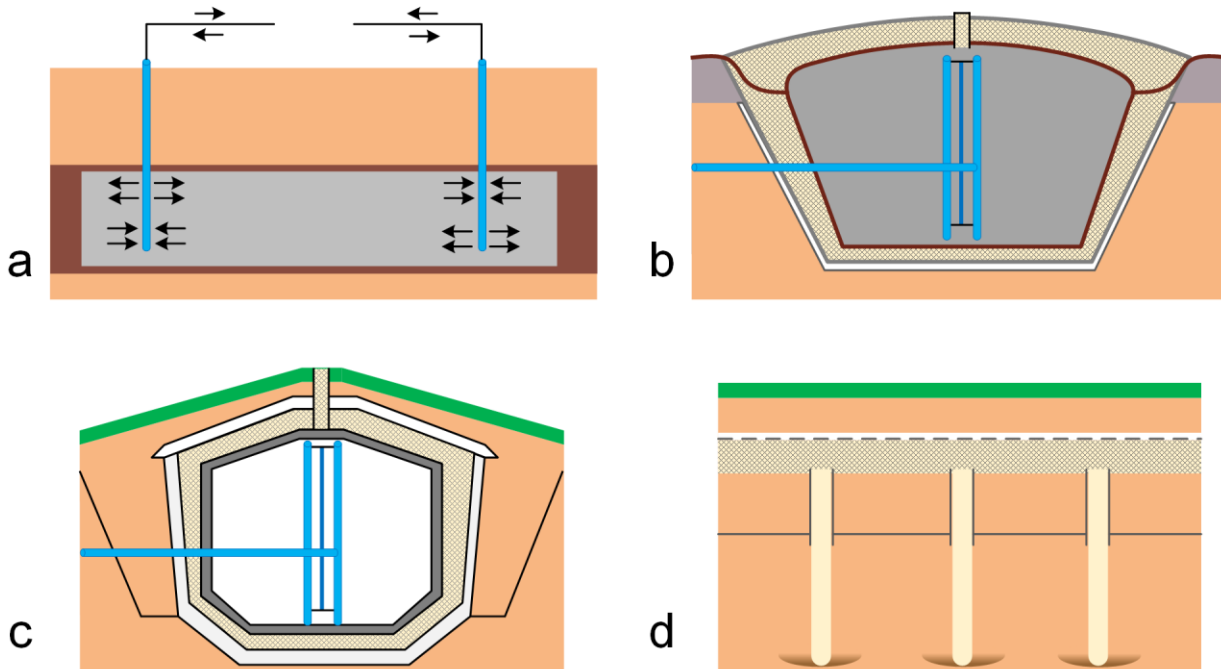

The most widely used way is to store solar heat at underground reservoirs

If solar collectors are connected to the boiler house, the heat can be transferred to both, accumulation tank and consumer supply

If the boiler house is located far from the field of solar collectors, then solar panels heat can be connected to the accumulation tank, but the tank is connected to the centralized heat supply of a municipality

Accumulated heat density indicator in underground reservoirs is 60-80 kWh/m³

Involvement of solar collectors' field into the centralized municipal heating system is practically solved, for example, in Almere, the Netherlands, where there is a «Sun island» formed which consists of the near-by field of solar collectors with a large accumulation tank

It is called an «island» because it is surrounded by an artificial surface water body

Usually around the field of collectors there is a fence and a care of lawn is performed by rabbits or sheep



Solar panels consist of «**solar cells**» – the electrical system devices that transform solar energy into electricity

Solar cells are capable of transmit the electricity to the nearby electricity system or directly to the consumer of electricity, or to accumulation batteries

Solar cells are combined in a transfer panel which is encapsulated in glass and plastic materials and usually is placed in an aluminum frame

The amount of energy generated depends on the surface, the level of radiation, the cell efficiency and orientation towards the Sun

Cells mostly are dark blue or black and covered with anti-reflective material that enhances the light absorption



One of the most important issues in elaboration of energy-efficient solar panels is a solar cell material

Energy efficiency of solar panels is still low – the most advanced cells are capable of providing only 2% energy efficiency, but commercially produced – 16-18%

Usually from 1 m² it is possible to obtain on average 80-85W, but from devices with higher efficiency - up to 130 W; solar panels generate direct currents power, which then needs to be converted into alternating current power

At present, the most used are silicon-based systems, but elaboration of the organic materials-based cells is promising and innovative direction

In Latvia the implementation of solar panels is at stage of development - some individual house owners have installed solar panels of a few m², but the first large solar power plant project has been implemented at the Munchausen Museum in Dunte



Opening of the solar power plant at the Munchausen Museum in Dunte

Wind power is the future of electricity power in Latvia, because it involves not only CO₂ neutral energy development, but also fossil energy substitution by renewable electricity

According to EU data, Latvia has a high capacity of wind power plants technological potential: it is stated that in the future it would be economically feasible to install a wind power devices of 1500 MWe

It is revealed that taking into account the capability of current wind technologies, wind turbines set into the offshore could be of 1000 MWe, but on land – 500 MWe

At present, the capacity of on-land wind turbines is less than 50 MWe

The beginning of wind energy technologies is attributed to windmills, but modern wind generators differ by power, the height, the axis type, the constructive and other parameters



There are two types of wind generators with a different axis types:

- **Wind turbines with a vertical axis of rotation**
- **Wind turbines with a horizontal axis of rotation**

Electrical generators also are of two types:

- **Asynchronous generators**
- **Synchronous generators**

Orientation of wind turbines against the wind is:

- **Wind power plants designed to operate against the wind (mostly)**
- **Wind power plants operating in the downwind (a wind wheel is located behind the tower)**



Wind generators differ by types of rotation:

- **Tail wing wind power plants - used in small-scale power stations**
- **Windroses – a rotation shaft is perpendicular to the main shaft of the wind power plant – used in medium-scale power stations**
- **Servo-engines, powered by the wind direction sensor – used in large-scale or medium-scale power stations**

Wind power plant classification by power capacity is conditional, because it is impossible to determine the exact power capacity:

- **Microstations – installed power capacity from 20 We to 3 kWe**
- **Small wind power stations – 3-30 kWe**
- **Medium stations – 30-500 kWe**
- **Large stations – more than 0.5 MWe**

Also a wind turbine height can be various:

- **10-15 m above the ground** – wind turbines installed on lampposts, at the house ridges
- **50 m above the ground** – poles are cheaper and of simple design
- **100 m above the ground** – sophisticated poles for larger generators
- **100-300 m above the ground** – launching a pilot studies with airships at such height

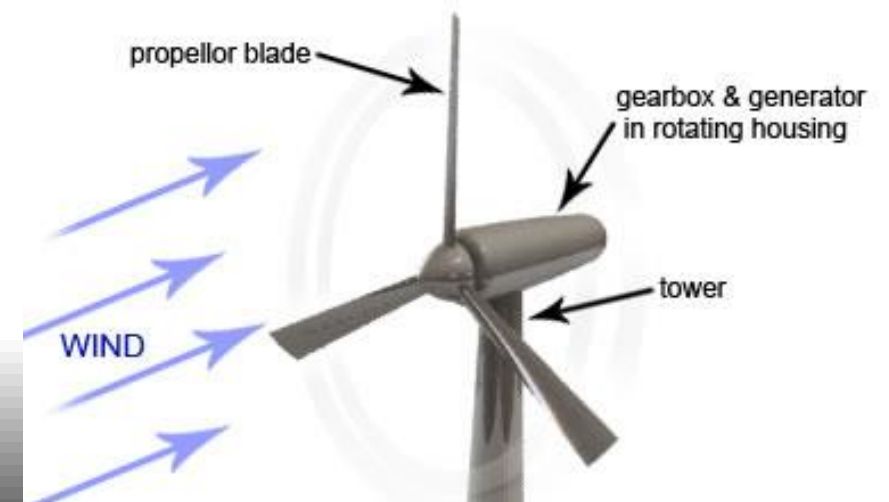

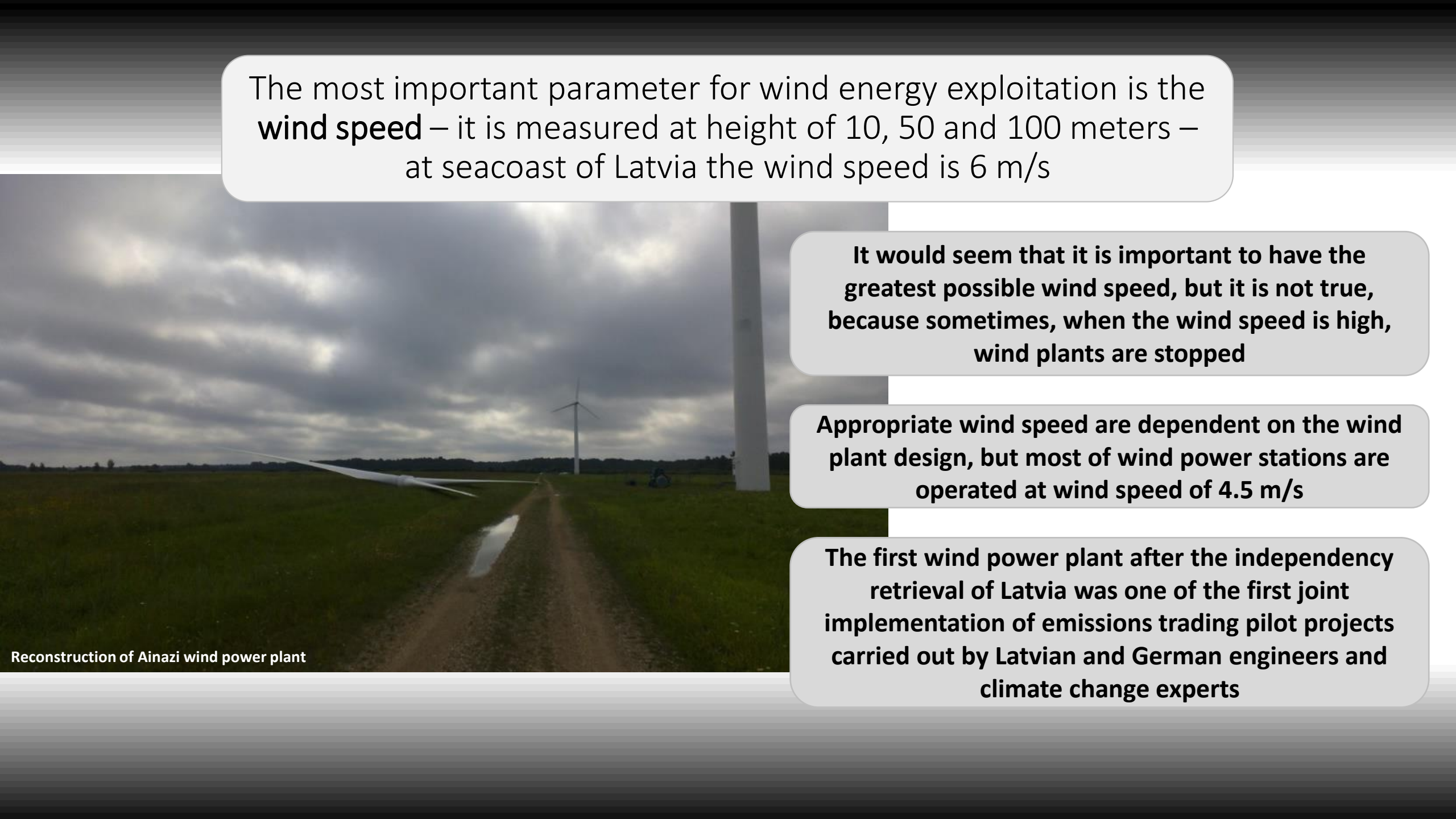

The most important parameter for wind energy exploitation is the **wind speed** – it is measured at height of 10, 50 and 100 meters – at seacoast of Latvia the wind speed is 6 m/s

It would seem that it is important to have the greatest possible wind speed, but it is not true, because sometimes, when the wind speed is high, wind plants are stopped

Appropriate wind speed are dependent on the wind plant design, but most of wind power stations are operated at wind speed of 4.5 m/s

The first wind power plant after the independency retrieval of Latvia was one of the first joint implementation of emissions trading pilot projects carried out by Latvian and German engineers and climate change experts

Hydroelectric power plants worldwide mainly are build on mountain rivers; experience of Latvia in this field can be considered as an exception, because large hydroelectric power plants are built on the plain River Daugava

Regarding the small hydropower stations, the maximum number has been reached, because currently in Latvia approximately 150 small hydropower plants are operating

Small hydropower stations are restored at the mills' lakes and built anew by moulding water tanks on the small plain rivers

Capacity of small hydropower stations can be increased only by installing energy-efficient equipment

Although the opinions of experts on the small hydropower stations' environmental impact are different, scientific research open the way for new solutions – innovative technological solutions of small hydropower plants are related to the current use of water streams, installing of hydroturbines in the middle of the river water in the center of flow

Plavinas Hydropower Plant in Aizkraukle in terms of the power capacity is the largest hydroelectric power plant in the Baltic States and the second largest in the European Union

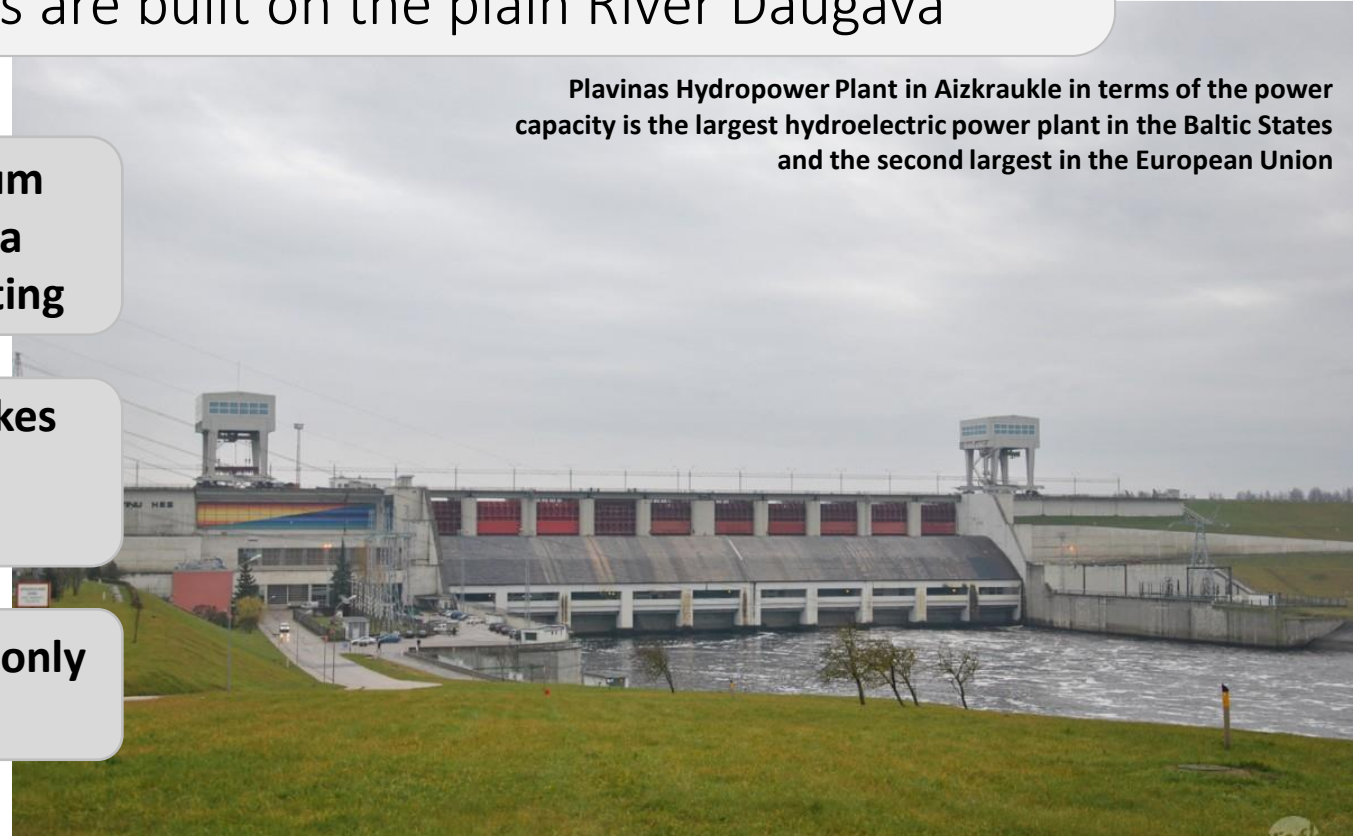

Geothermal energy, wave energy and tidal energy already is used worldwide – and sooner or later in the future will appear more sources of renewable energy

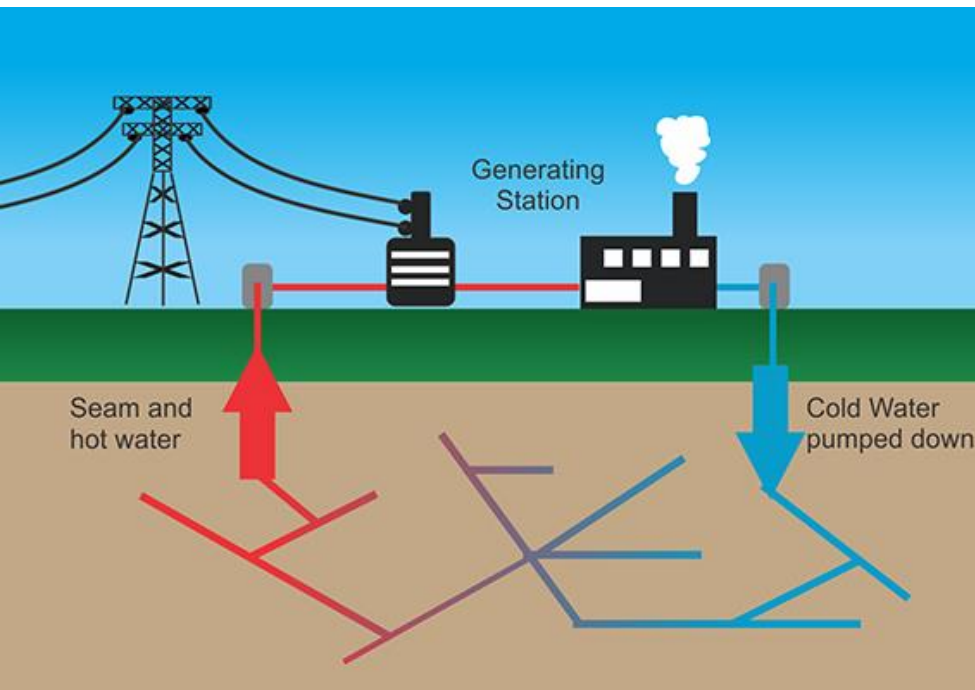

An example of use of geothermal energy is the area of volcanic activities in Iceland where hot underground water is used for heating, industry and medicine

In Europe, geothermal energy plants mostly are built at households as heat and hot water supply for private houses

Some of geothermal energy projects are implemented in Europe for industrial needs of both, heat and cold supply, for example, in Klaipeda city, Lithuania, geothermal energy is used in centralized heating system

Currently, use of geothermal energy has a small role in the energy sector, however, technological development could be linked with increased use of renewable electricity, e.g., using heat pumps

Operating modes of renewable electrical energy power sources are characterized by their availability – there are three types of power sources:

- I. **The first group** – the biomass, including biogas, co-generation plants, and geothermal power electrical stations that can work continuously, according to electricity demand
- II. **The second group** – the solar and wind energy sources, as well as wave and tidal power plants that works periodically and inpermanently, depending on the supply of daily, weekly, monthly and annually available resources
- III. **The third group** – the electricity power sources that can be quickly turned on and off at times when consumers need additional electricity to cover the electricity system of the missing energy such as hydropower plants; these power sources cover a complementary power system stability and safety integrating the second group of energy producers



The fourth technological solution for the integration of renewable energy resources into national or regional energy balance is **the storage of electricity** produced by the second group of irregular energy suppliers



For efficient use of solar and wind energy potential, production of wind and solar energy accumulation technologies has to be developed

Storage possibilities of renewable energy makes electricity consumers less dependent on weather conditions, allows to sell electricity at a preferential price and helps optimization the use of limited network capacity

Technologies that provide accumulation of electricity produced are various – more used are accumulation devices such as different types of batteries and accumulators, but they are not designed for a large amount of energy storage

Riga Technical University is investigating hydrogen accumulation of power produced from renewable energy resources, modelling hydrogen use in creation of biomethane production accumulation system

Elements of irregular electricity hydrogen-biomethane accumulation system:

1. Solar panels (irregular electricity source)
2. Wind generators (intermittent power source)
3. Electrolytic hydrogen production system using electric power
4. Bioreactor substrate supply (supplies with, e.g., agricultural waste, manure, algae biomass etc.)
5. Bioreactor – biogas production under anaerobic conditions, where the end products of the digester are methane and CO₂
6. Digestate storage tank
7. Biomethanation supply equipment for biogas (methane and CO₂)
8. Biomethanation plant – biogas from bioreactor is supplied to biomethanation facility where also enters hydrogen to increase the concentration of methane in biogas and to reduce the concentration of CO₂
9. Biomethanation hydrogen supply equipment
10. Biomethane storage reservoir
11. Oxygen outlet from the electrolysis unit

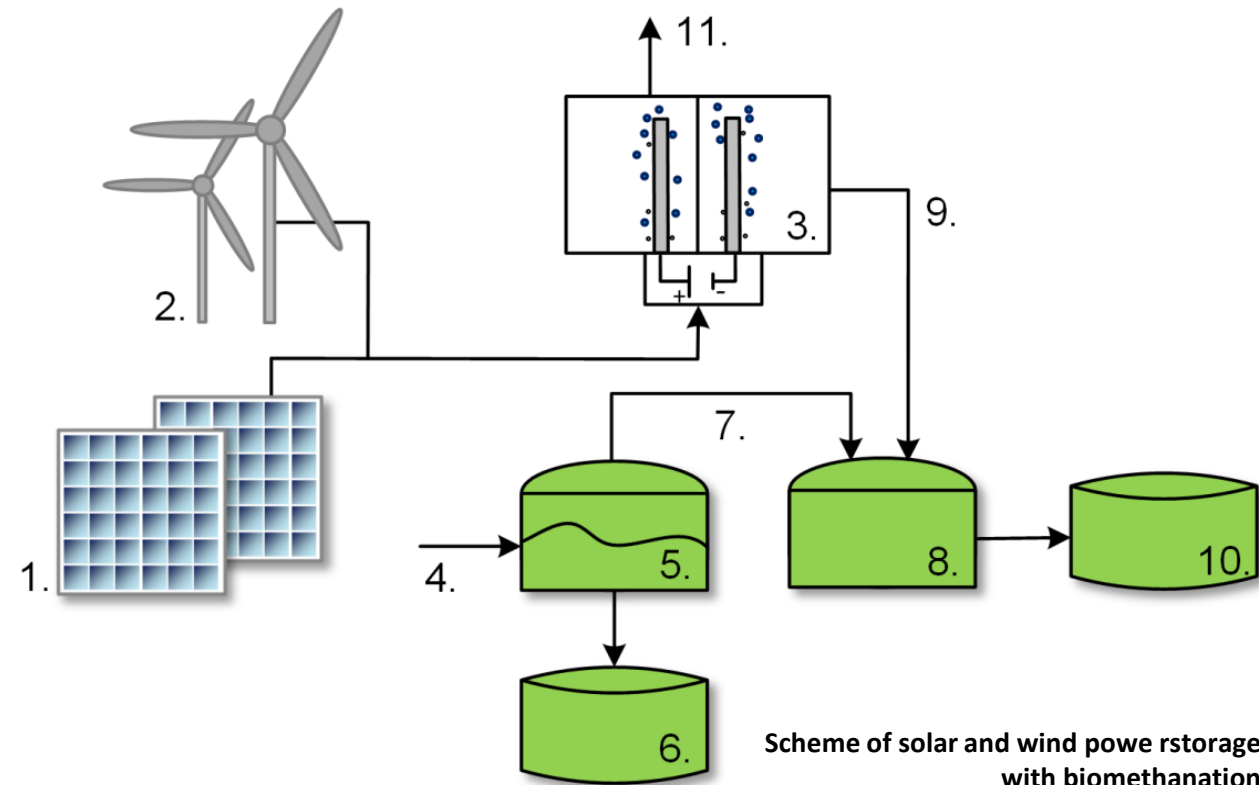

CO₂ STORAGE POSSIBILITIES

One of the development directions of climate technologies is **CO₂ storage** that helps to reduce CO₂ emissions, ensuring energy production with zero CO₂ emissions into the atmosphere

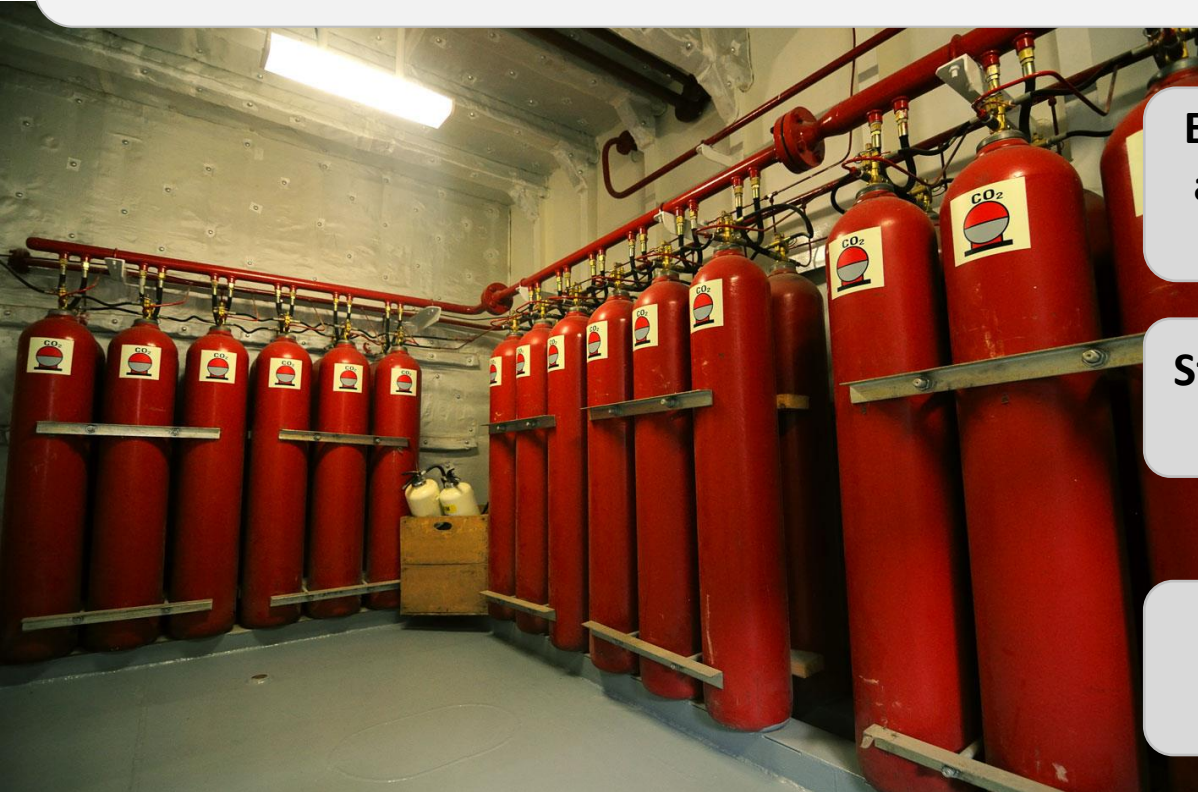

Energy production and industrial processes using fossil fuels, are the main objects, which carbon emissions can be stored in special storage facilities

Storage of CO₂ is use of CO₂ emissions into chemical reactions and biological processes

CO₂ storage technologies can be divided into five stages:

- Co-generation stations
- CO₂ separation
- CO₂ compression
- CO₂ transport
- CO₂ storage

One of the climate technologies – **co-generation stations** are energy efficient energy source which simultaneously produces heat and electricity

CO₂ emitted from fuel combustion can be reduced in two ways – one of the most important conditions for the storage is to extract pure CO₂ without impurities

Climate technology solutions are different: technologically reducing the formation of impurities in the furnace and purifying flue gases from the other gases such as N and NO_x, as well as through the combined removal of impurities

Currently, there are different CO₂ storage options which has both, advantages and disadvantages

- Oceans and seas
- Coal mines
- Gas reservoirs
- Natural underground reservoirs
- CO₂ mineralization
- CO₂ industrial use

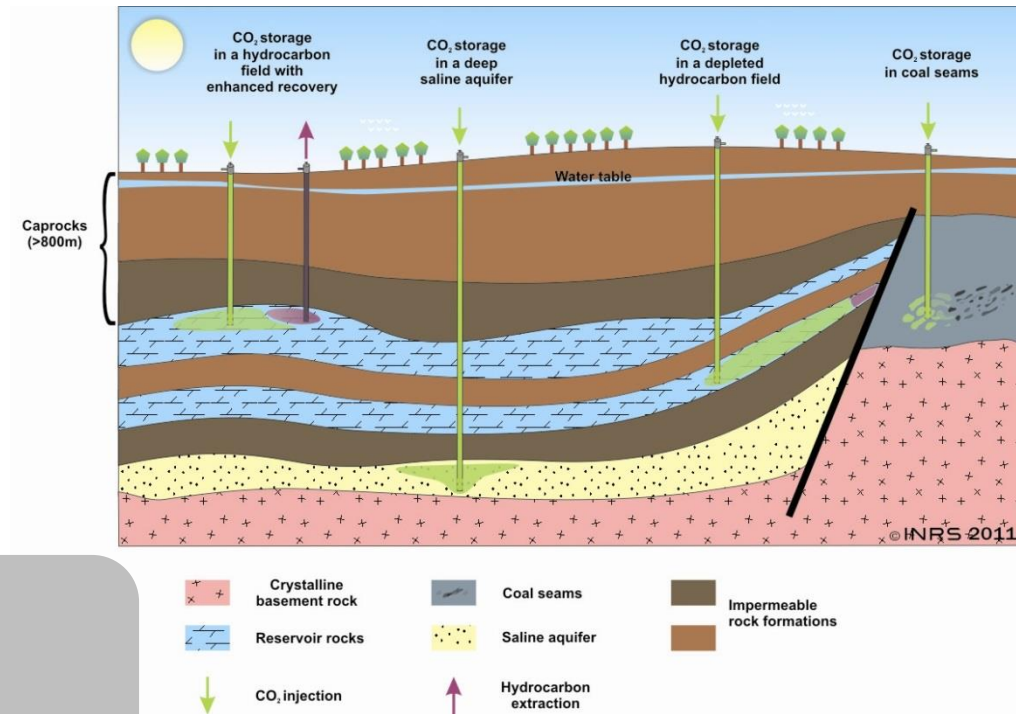

Development of carbon storage methods and their wide range in the future will make a right choice on the most appropriate technological solutions, taking into account:



- **Legislative arrangement:** public facilities and energy development strategies and policy
- **Geographical considerations:** underground storage availability and location in nature
- **Engineering techniques:** availability of technological solutions and innovation level
- **Accessibility to storages:** storage capacity or storage duration
- **Economic considerations:** necessary investment, service and maintenance costs
- **Environmental requirements:** environmental impact assessment
- **Resilience level:** storage security
- **Other conditions**

The greatest opportunities for carbon storage is the implementation of mineralization process, as a result of which **CO₂ gas is converted into solids** such as carbonate or bicarbonate

The final product of mineralization process is easily transportable, storable above the ground, can be used as a raw material in production facilities where it is possible to increase the added value, e.g., by production of building materials

Real volumes of CO₂ storage capacity are not exactly known for several reasons: carbon storage innovation develops and it adjusts the access and choice of methods

CO₂ storage facilities and the potential storage capacity

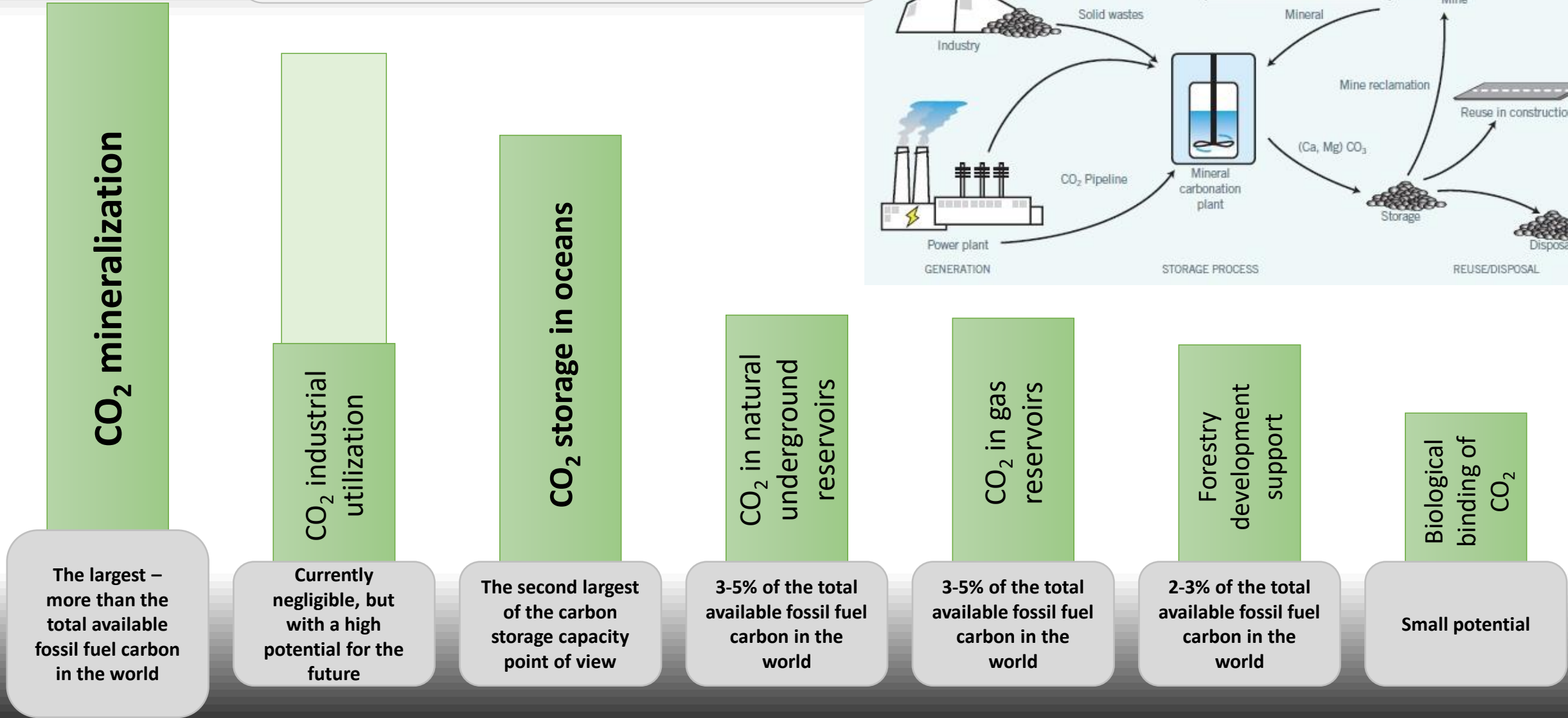

CO₂ storage duration is the second most important parameter when choosing which method is preferable, since it identifies the length of time in which CO₂ emissions will return in the atmosphere

Therefore, natural processes such as use of CO₂ in the growth processes in plants, trees are not considered to be significant CO₂ storage method as shelf life is small in comparison with storage in the oceans which counts from a hundred years and more

Particularly important shelf life is because that is invested in the energy, financial and material resources and time spent on emissions for CO₂ capture in factories, power plants and other places where the use of fossil fuels

Fast return in large amounts of CO₂ into the environment from CO₂ storages is not economically viable and can pose a threat to the environment and people

Environmental issues can be differently interpreted and can point out the shortcomings of storage methods, however, the storage of CO₂ is a solution to the problem

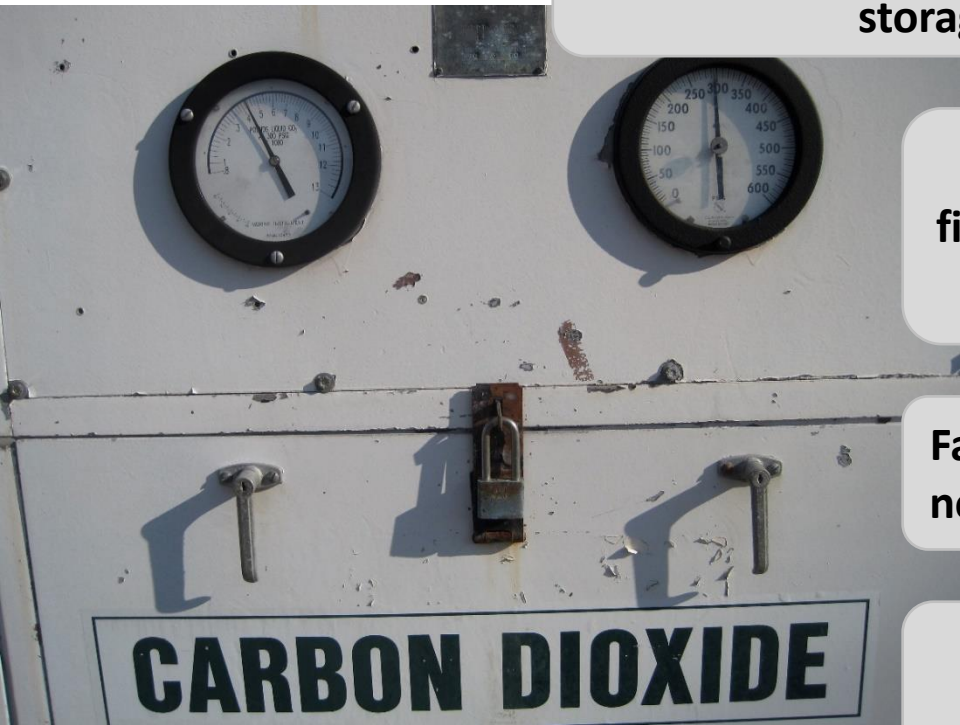

Thank you
for the attention!

